

CARROS
MULTIFUNCIONALES
CESTAS
ISO MODULAR

*MULTIFUNCTIONAL
HOSPITAL TROLLEY
BASKETS
ISO MODULAR*





Los carros que a continuación les presentamos aportan una solución práctica y de gran utilidad para usos diversos, tales como: Carros de curas, carros de anestesia, carros de urgencias, carros de parada, carros de enfermería, carros de cuidados intensivos, carros de medicación, carros de U.C.I., carros de almacenamiento, carros de historias clínicas, etc.

The following trolleys that we present you contribute a practical solution and very useful for diverse uses, such as: clinic file trolleys, cure trolleys, anesthesia, urgencies, infirmary, medication, I.C.U.

_Incluye cestas ISO modular extraíbles 600 x 400mm

_Includes removable baskets ISO modular 600 x 400mm

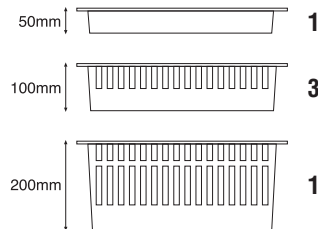

50000

- + 50900
- + 50905
- + 50910
- + 50920
- + 50935
- + 50955

50000

CARACTERÍSTICAS TÉCNICAS

- _Estructura de aluminio y paneles estratificados con revestimiento plastificado
- _Plano superior de ABS con reborde en tres lados
- _Base con protección antigolpes de poliuretano integral (PUR)
- _Guías telescópicas con autocierre y marco ISO 600 x 400mm
- _Apertura total 110%
- _Empujador ergonómico de poliuretano integral (PUR)
- _Ruedas de 125mm dos con freno
- _Equipados opcionalmente con accesorios (ver páginas 70 a 74)
- _Elija colores en carta de colores (ver página 75)

TECHNICAL CHARACTERISTICS

- _Aluminium structure and stratified side panels with plasticized coating
- _Upper ABS platform on top with extended up rims on three sides
- _Base with polyurethane integral bumper protection (PUR)
- _Telescopic slides with automatic shutting system and frame ISO 600 x 400mm
- _Total opening 110%
- _Ergonomic pushing handle of polyurethane integral (PUR)
- _125mm rolling wheels, two with brakes
- _Equipped with optional accessories. (see page 70 to 74)
- _Choose your colour (see page 75)



50000	80	58	98	60	0.45





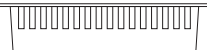

_Incluye cestas ISO modular extraibles 600 x 400mm

_Includes removable baskets ISO modular 600 x 400mm

50mm |  1

100mm |  1

					
50030	80	58	98	60	0.45
50035	80	58	98	63	0.45

- _Incluye cestas ISO modular extraíbles 600 x 400mm
- _Includes removable baskets ISO modular 600 x 400mm

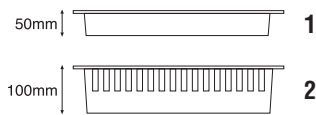

50035



CARACTERÍSTICAS TÉCNICAS

- _Estructura de aluminio y paneles estratificados con revestimiento plastificado
- _Plano superior de ABS con reborde en tres lados
- _Base con protección antigolpes de poliuretano integral (PUR)
- _Guías telescópicas con autocierre y marco ISO 600 x 400mm
- _Apertura total 110%
- _Parte inferior panel con guías para cestas o estantes
- _Empujador ergonómico de poliuretano integral (PUR)
- _Ruedas de 125mm dos con freno
- _Equipados opcionalmente con accesorios (ver páginas 70 a 74)
- _Elija colores en carta de colores (ver página 75)

TECHNICAL CHARACTERISTICS

- _Aluminium structure and stratified side panels with plasticized coating
- _Upper ABS platform on top with extended up rims on three sides
- _Base with polyurethane integral bumper protection (PUR)
- _Telescopic slides with automatic shutting system and frame ISO 600 x 400mm
- _Total opening 110%
- _Lower part with liner panels for baskets or shelves
- _Ergonomic pushing handle of polyurethane integral (PUR)
- _125mm rolling wheels, two with brakes
- _Equipped with optional accessories. (see page 70 to 74)
- _Choose your colour (see page 75)

50050

+ 50915



_Incluye cestas ISO modular extraibles 600 x 400mm

_Includes removable baskets ISO modular 600 x 400mm

50mm |  1

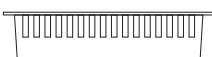
100mm |  1

50050



50055

+ 50920
+ 50945





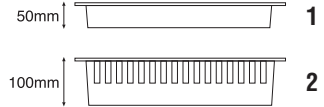

_ Incluye cestas ISO modular extraíbles 600 x 400mm

_ Includes removable baskets ISO modular 600 x 400mm



50055



					
50050	80	58	98	70	0.45
50055	80	58	98	75	0.45

CARACTERÍSTICAS TÉCNICAS

- _ Estructura de aluminio y paneles estratificados con revestimiento plastificado
- _ Plano superior de ABS con reborde en tres lados
- _ Base con protección antigolpes de poliuretano integral (PUR)
- _ Guías telescópicas con autocierre y marco ISO 600 x 400mm
- _ Apertura total 110%
- _ Parte inferior panel con guías para cestas o estantes
- _ Empujador ergonómico de poliuretano integral (PUR)
- _ Ruedas de 125mm dos con freno
- _ Equipados opcionalmente con accesorios (ver páginas 70 a 74)
- _ Elija colores en carta de colores (ver página 75)

TECHNICAL CHARACTERISTICS

- _ Aluminium structure and stratified side panels with plasticized coating
- _ Upper ABS platform on top with extended up rims on three sides
- _ Base with polyurethane integral bumper protection (PUR)
- _ Telescopic slides with automatic shutting system and frame ISO 600 x 400mm
- _ Total opening 110%
- _ Lower part with liner panels for baskets or shelves
- _ Ergonomic pushing handle of polyurethane integral (PUR)
- _ 125mm rolling wheels, two with brakes
- _ Equipped with optional accessories. (see page 70 to 74)
- _ Choose your colour (see page 75)

50785

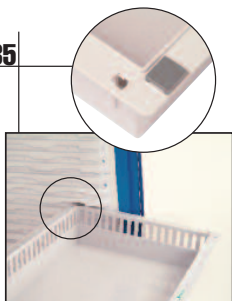

- _Tope de salida de bandeja incluido
- _Pull-out stopper included



- _Incluye cestas ISO modular extraíbles 600 x 400mm
- _Includes removable baskets ISO modular 600 x 400mm

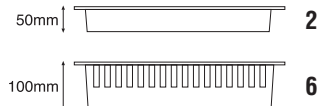

- _Pueden poner cestas según sus necesidades
- _You can put baskets according your needs

50100



CARACTERÍSTICAS TÉCNICAS

- _Estructura de aluminio y paneles estratificados con revestimiento plastificado
- _Plano superior de ABS con reborde en tres lados
- _Base con protección antigolpes de poliuretano integral (PUR)
- _Panel con guías para cestas o estantes ISO 600 x 400mm
- _Dos puertas abatibles
- _Cerradura con llave
- _Empujador ergonómico de poliuretano integral (PUR)
- _Ruedas de 125mm dos con freno
- _Equipados opcionalmente con accesorios (ver páginas 70 a 74)
- _Elija colores en carta de colores (ver página 75)

TECHNICAL CHARACTERISTICS

- _Aluminium structure and stratified side panels with plasticized coating
- _Upper ABS platform on top with extended up rims on three sides
- _Base with polyurethane integral bumper protection (PUR)
- _Panel for baskets or shelves ISO 600 x 400mm
- _Two doors
- _Locking key
- _Ergonomic pushing handle of polyurethane integral (PUR)
- _125mm rolling wheels, two with brakes
- _Equipped with optional accessories. (see page 70 to 74)
- _Choose your colour (see page 75)

50100	80	58	120	62	0.56
50110	80	58	156	75	0.72

50785

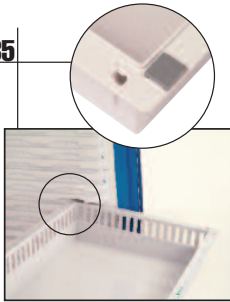

_Tope de salida de bandeja incluido

_Pull-out stopper included



50110

_Incluye cestas ISO modular extraíbles 600 x 400mm
_Includes removable baskets ISO modular 600 x 400mm

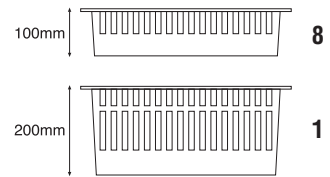

_Pueden poner cestas según sus necesidades
_You can put baskets according your needs



50070

- + 50915
- + 50920
- + 50925



10206



CARACTERÍSTICAS TÉCNICAS





- _Estructura de aluminio y paneles estratificados con revestimiento plastificado
- _Plano superior de ABS con reborde en tres lados
- _Base con protección antigolpes de polietileno
- _Guías telescópicas con autocierre y marco
- _Seis cajones con cestas ISO de 450x400x100mm
- _Apertura total 110%
- _Empujador lateral
- _Ruedas de 125mm, dos con freno
- _Consultar accesorios (ver páginas 70 a 74)

Colores disponibles: rojo, azul y verde

TECHNICAL CHARACTERISTICS

- _Aluminium structure and stratified side panels with plasticized coating
- _ABS platform on top with extended up rims on three sides
- _Base with polyethylene integral bumper protection (PUR)
- _Telescopic slides with automatic shutting system and frame
- _Six drawers with ISO basket of 450x400x100mm
- _100% opening
- _Pushing handle
- _125mm rolling wheels, two with brakes
- _Consult accessories (see page 70 to 74)

Colours available: red, blue and green

					
10204	62	54	98	57	0.33
10206	62	54	98	57	0.33

50075

_Panel con guías para cestas
_Cinco cestas ISO DE 450x400x100mm
(sin separadores) (opcional)

_Panels with slides for baskets
_Five ISO baskets of 450x400x100mm
(dividers not include) (optional)



CARACTERÍSTICAS TÉCNICAS

- _Estructura de aluminio y paneles estratificados con revestimiento plastificado
- _Plano superior de ABS con reborde en tres lados
- _Base con protección antigolpes de polietileno
- _Dos puertas abatibles
- _Cerradura con llave
- _Empujador lateral
- _Ruedas de 125mm, dos con freno
- _Consultar accesorios (ver páginas 70 a 74)
- Colores disponibles: rojo, azul y verde**

TECHNICAL CHARACTERISTICS

- _Aluminium structure and stratified side panels with plasticized coating
- _ABS platform on top with extended up rims on three sides
- _Base with polyethylene integral bumper protection (PUR)
- _Two doors
- _Locking key
- _Pushing handle
- _125mm rolling wheels, two with brakes
- _Consult accessories (see page 70 to 74)
- Colours available: red, blue and green**

50115
+ 50520

50115

- _Encimera plastificada
- _5 guías para cestas o estantes
- _Plasticized top
- _5 guides for baskets or shelves

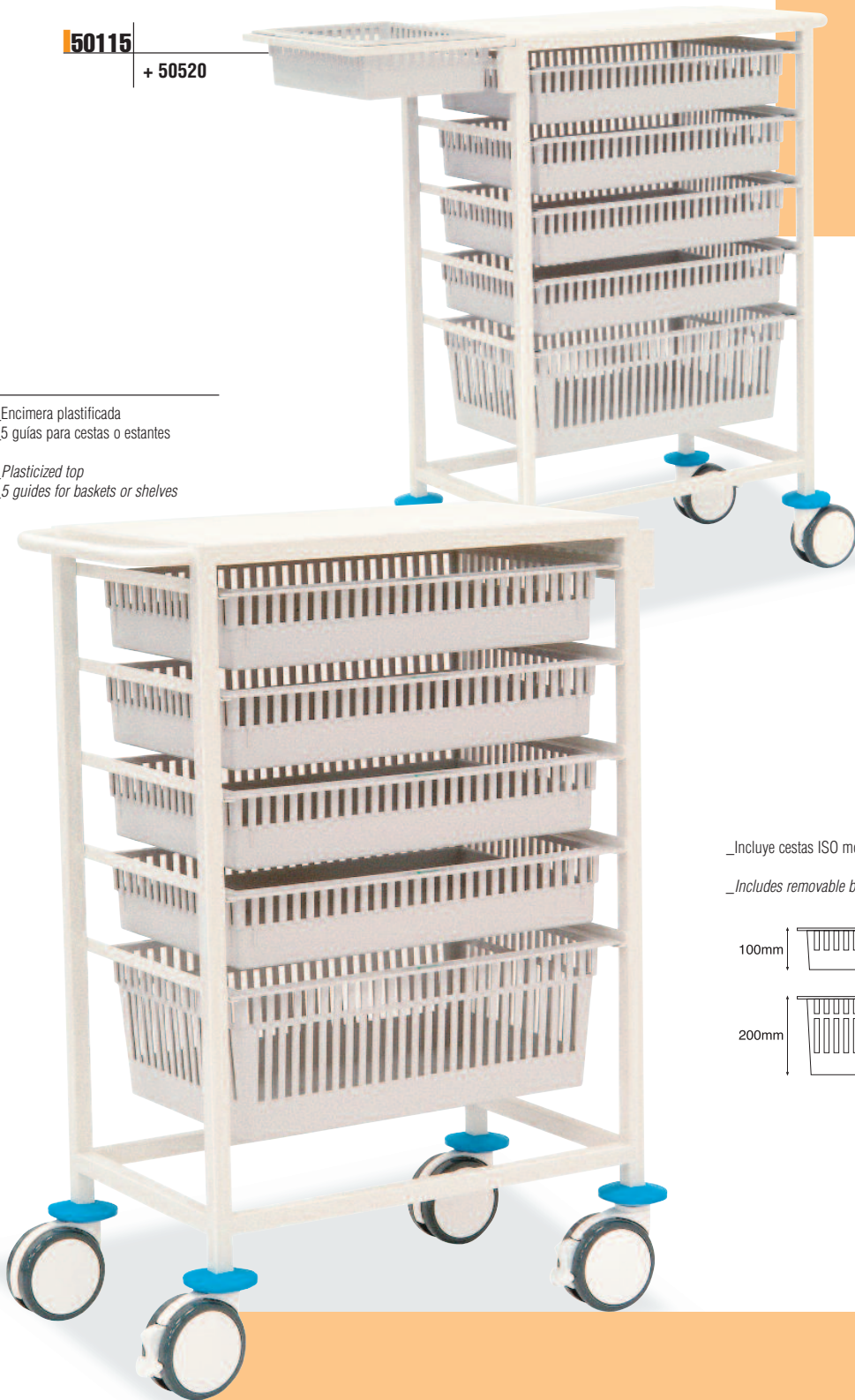

_Incluye cestas ISO modular extraíbles 600 x 400mm

_Includes removable baskets ISO modular 600 x 400mm

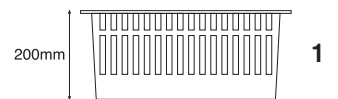

50785

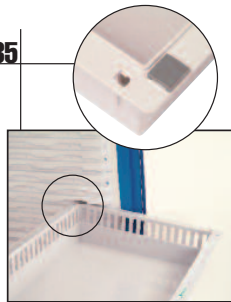

_Tope de salida de bandeja incluido

_Pull-out stopper included

50120

_10 guías para cestas o estantes

_10 guides for baskets or shelves

_Incluye cestas ISO modular extraíbles 600 x 400mm

_Includes removable baskets ISO modular 600 x 400mm

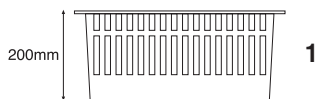





CARACTERÍSTICAS TÉCNICAS

- _Estructura de acero con revestimiento en epoxy
- _Parte superior estante
- _Empujador
- _Protección antigolpes
- _Ruedas de 125mm dos con freno
- _OPCIONAL: Soporte para bandeja de 400 x 300mm

TECHNICAL CHARACTERISTICS

- _Steel structure with epoxy coating
- _upper shelf
- _Pushing handle
- _Bumper protection
- _125mm rolling wheels, two with brakes
- _OPTIONAL: side support for shelf of 400 x 300mm

					
50115	74	42	110	25	0.34
50120	74	42	157	36	0.49

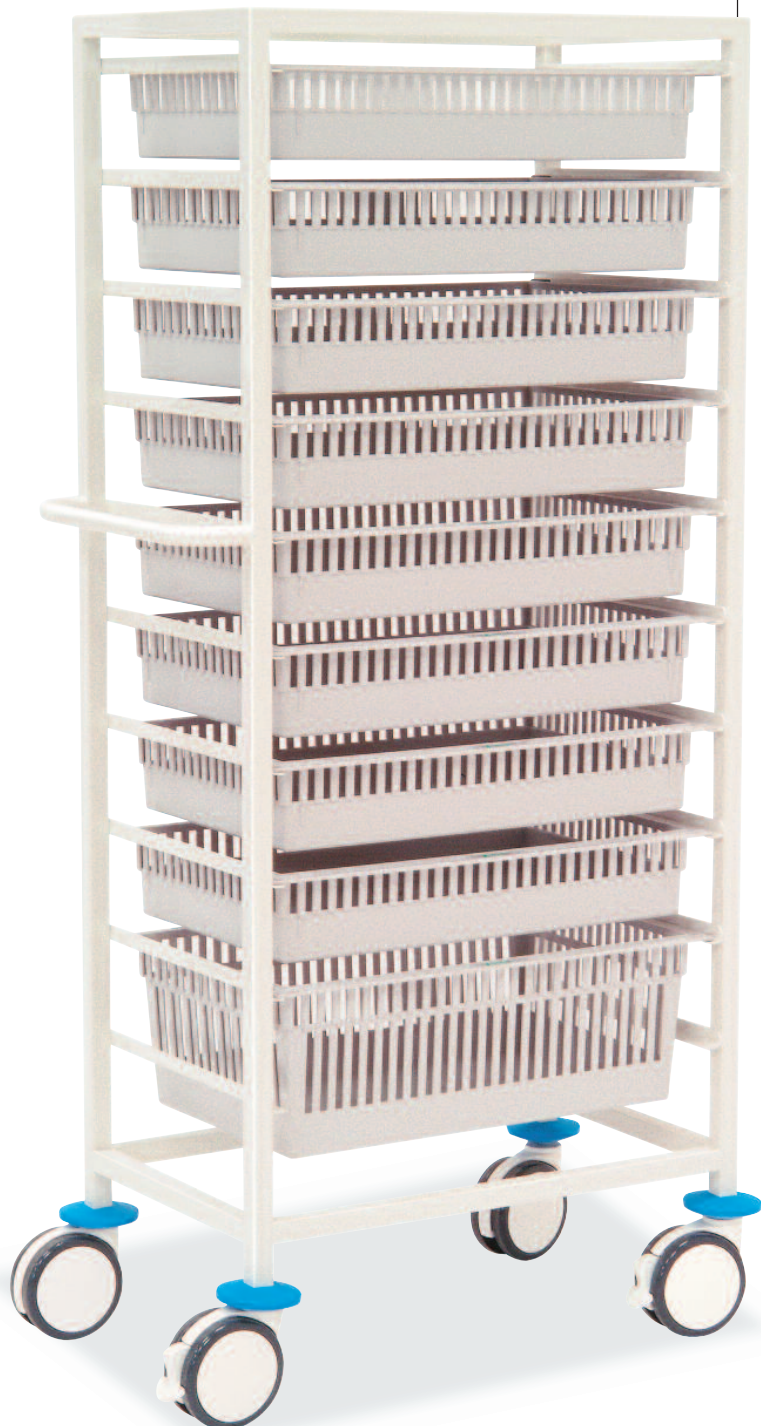



50200

- _ Dos puertas abatibles
- _ Mesa escritorio extraíble
- _ Two doors
- _ Sliding out writing-desk

CARACTERÍSTICAS TÉCNICAS

- _ Estructura de aluminio y paneles estratificados con revestimiento plastificado
- _ Plano superior de ABS con reborde en tres lados
- _ Base con protección antigolpes de poliuretano integral (PUR)
- _ Mesa escritorio extraíble
- _ 22 divisores para radiografías de 360 x 430mm
- _ Empujador ergonómico
- _ Ruedas de 125mm dos con freno
- _ Equipados opcionalmente con accesorios (ver páginas 70 a 74)
- _ Elija colores en carta de colores (ver página 75)

TECHNICAL CHARACTERISTICS

- _ Aluminium structure and stratified side panels with plasticized coating
- _ Upper ABS platform on top with extended up rims on three sides
- _ Base with polyurethane integral bumper protection (PUR)
- _ Sliding out writing-desk
- _ 22 compartments for x-rays of 360 x 430mm
- _ Ergonomic pushing handle
- _ 125mm rolling wheels, two with brakes
- _ Equipped with optional accessories. (see page 70 to 74)
- _ Choose your colour (see page 75)

50215

_Carpeta para historias clinicas





_Folder for clinic files



50220

_Un cajón para carpetas verticales de historias clinicas
_11 divisores para radiografías de 360 x 430mm

_One drawer for vertical clinic files folders
_11 compartments for x-rays of 360 x 430mm

					
50200	80	58	120	90	0.56
50210	80	58	120	77	0.56



Además de los carros también encontrará un conjunto de bandejas y separadores que de una manera fácil e intuitiva le permitirá personalizar a su gusto o necesidades todos los compartimentos, creando así un espacio de trabajo más cómodo y práctico. Los separadores le permiten la compartimentación de las cestas tanto horizontal como transversalmente.

In addition to the trolleys, you will also find a set of trays and dividers that an easy and intuitive way, will allow you to personalizing according your preferences or needs of all compartments, creating a comfortable and practical space to work. The dividers allow you the compartment of the baskets horizontal as well as transversely.

50500

_Cestas ISO modular de ABS

_ISO Modular basket of ABS



50505

_Cestas ISO modular de ABS

_ISO Modular basket of ABS



50510





50515



50520



			
50500	60	40	1,5
50505	60	40	5
50510	60	40	10
50515	60	40	20
50520	40	30	10

CARACTERÍSTICAS TÉCNICAS

_Cesta ISO modular para medicamentos y materiales fungibles
_Fabricada en ABS

TECHNICAL CHARACTERISTICS

_ISO Modular basket for drugs and expendable goods
_Made of ABS



_Elige tus necesidades

_Your needs

50630

_Separador ajustable cada 10mm

_Adjustable cross divider every 10mm

600 x 50mm

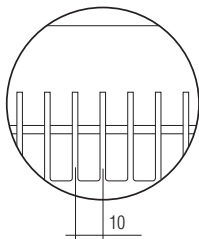
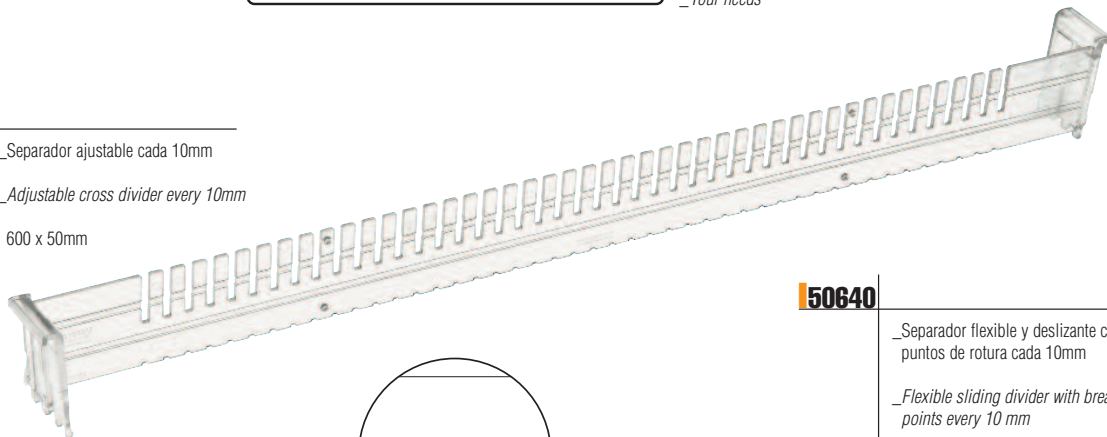

50640

_Separador flexible y deslizante con puntos de rotura cada 10mm

_Flexible sliding divider with breaking points every 10 mm

170 x 45mm

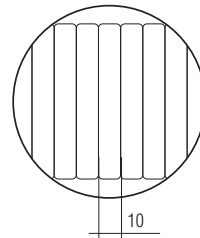
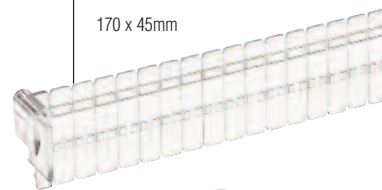

50635

400 x 50mm

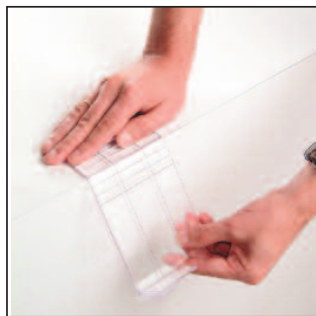
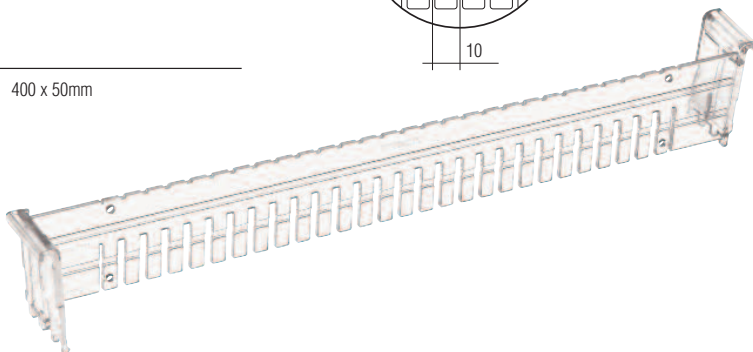

_Puedes obtener las medidas que necesites con solo romper por los puntos de rotura

_To shorten the dividers, just break off the scored sections

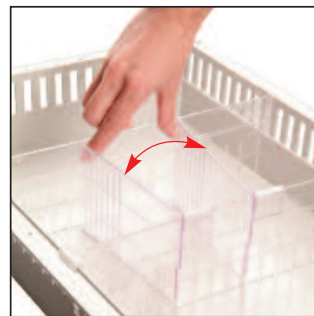
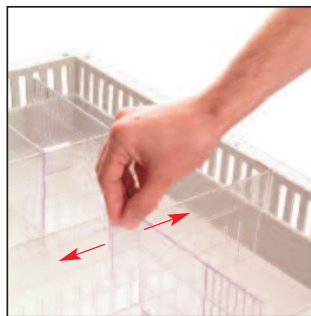

_Los separadores deslizantes son fáciles de cambiar y mover

_The sliding dividers are really easy to move and change

Separaciones para cestas de 600 x 400 x 50mm
 Dividers for baskets of 600 x 400 x 50mm



50600

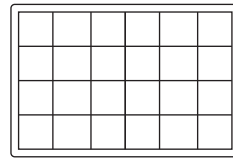

24

_Compartimentos
 _Compartment

50605

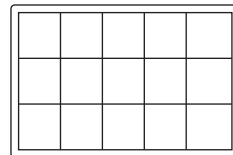

15

_Compartimentos
 _Compartment

50610

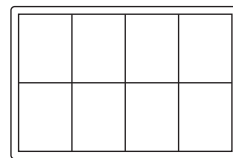

8

_Compartimentos
 _Compartment

_Separadores variables ajustables cada 10mm

_Adjustable cross dividers every 10mm

50615

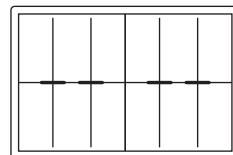

12

_Compartimentos
 _Compartment

50620

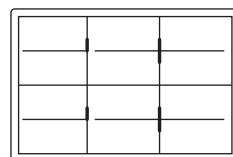

12

_Compartimentos
 _Compartment

50625

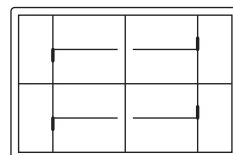

12

_Compartimentos
 _Compartment

_Separadores variables y deslizantes con puntos de rotura cada 10mm

_Adjustable cross dividers and flexible sliding dividers with breaking points every 10mm



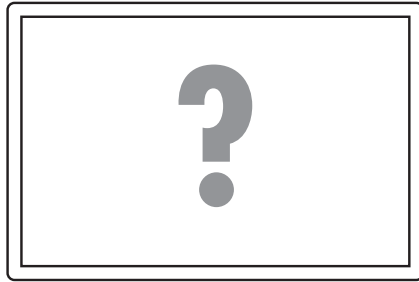

_Elige tus necesidades

_Your needs

50675

_Separador ajustable cada 20 mm

_Adjustable cross dividers every 20mm

600 x 100mm

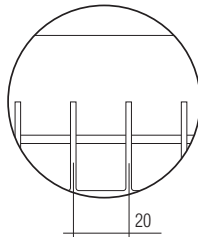
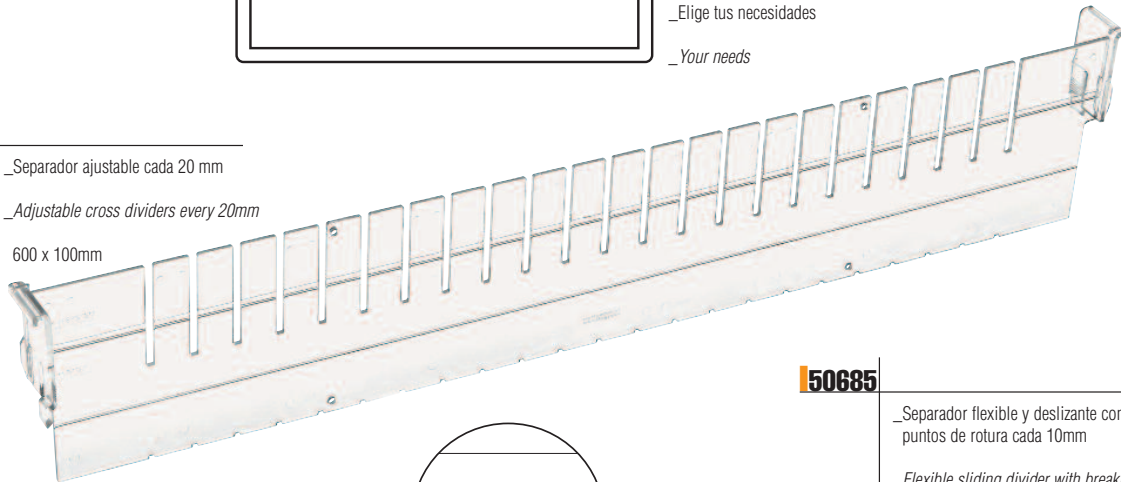

50685

_Separador flexible y deslizante con puntos de rotura cada 10mm

_Flexible sliding divider with breaking points every 10mm

170 x 100mm

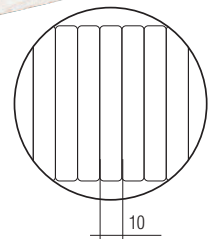
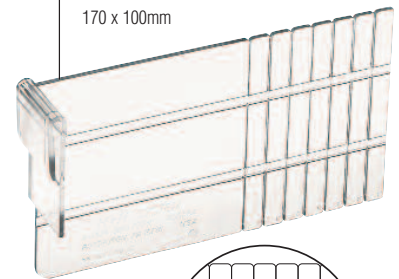

50680

400 x 100mm

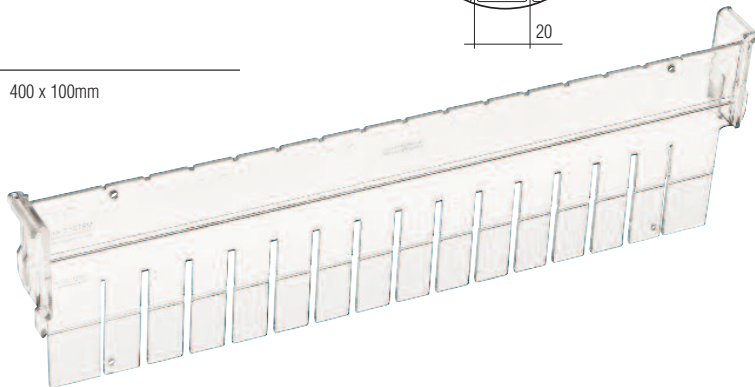

_Puedes obtener las medidas que necesites con solo romper por los puntos de rotura

_To shorten the dividers, just break off the scored sections

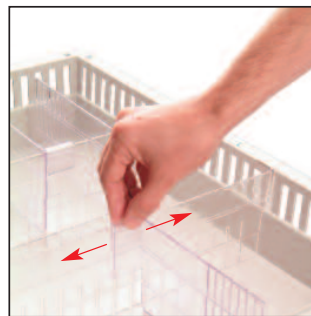
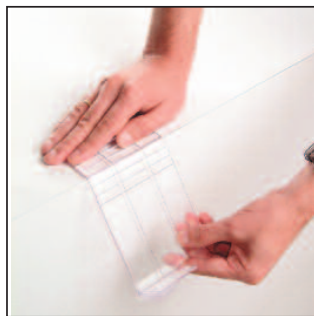

_Los separadores deslizantes son fáciles de cambiar y mover

_The sliding dividers are really easy to move and change

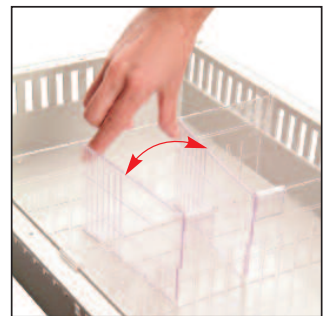

Separaciones para cestas de 600 x 400 x 100mm
 Dividers for baskets of 600 x 400 x 100mm



50645

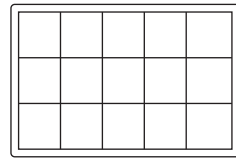

15

_Compartimentos
_Compartment

50650

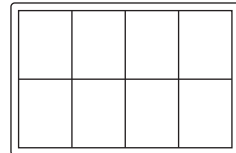

8

_Compartimentos
_Compartment

50655

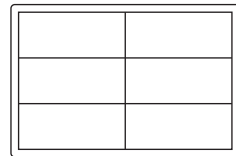

6

_Compartimentos
_Compartment

_Separadores variables ajustables cada 20mm

_Adjustable cross divider every 20mm

50660

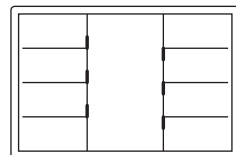

9

_Compartimentos
_Compartment

50665

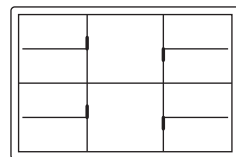

10

_Compartimentos
_Compartment

50670

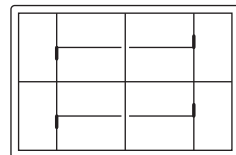

12

_Compartimentos
_Compartment

_Separadores variables y deslizantes con puntos de rotura cada 10mm

_Adjustable cross divider and flexible sliding dividers with breaking points every 10mm



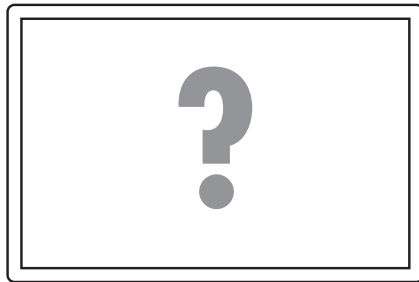

_Elige tus necesidades

_Your needs

50720

_Separador ajustable cada 140mm

_Adjustable cross divider every 140mm

600 x 200mm

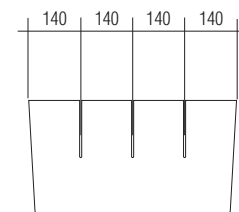
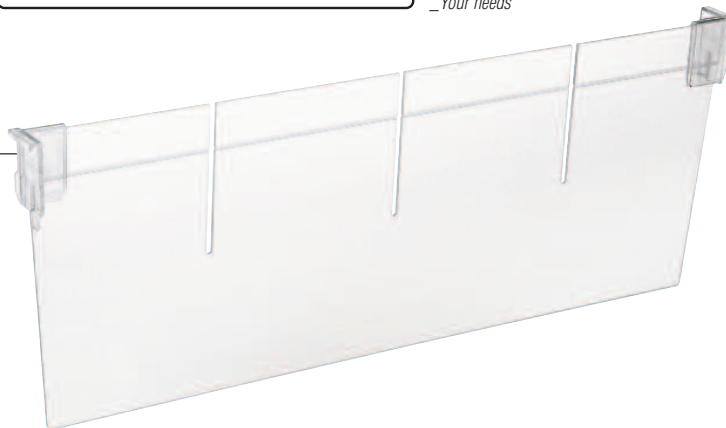

50725

_Separadores ajustable cada 60mm

_Adjustable cross divider every 60mm

400 x 200mm

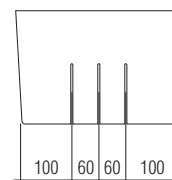
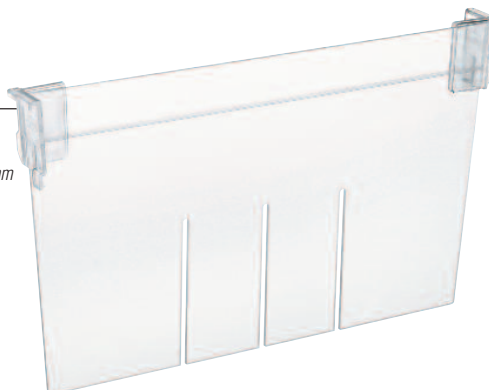

_Los separadores deslizantes son fáciles de cambiar y mover

_The sliding dividers are really easy to move and change

50730

_Separador deslizante

_Sliding divider

150 x 200mm



Separaciones para cestas de 600 x 400 x 200mm
 Dividers for baskets of 600 x 400 x 200mm



50690

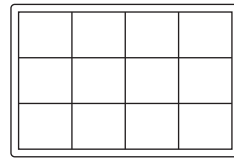

12
 _Compartimentos
 _Compartment

50695

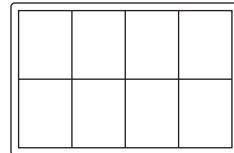

8
 _Compartimentos
 _Compartment

50700

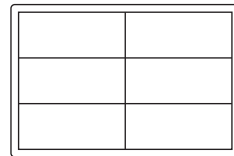

6
 _Compartimentos
 _Compartment

_Separadores variables y ajustables
 _Adjustable cross dividers



50705

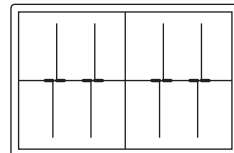

12
 _Compartimentos
 _Compartment

50710

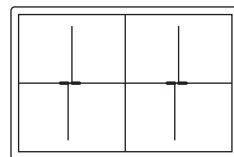

8
 _Compartimentos
 _Compartment

50715

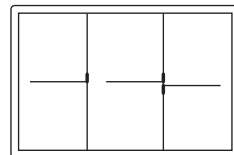

6
 _Compartimentos
 _Compartment

_Separadores variables y deslizantes
 _Adjustable cross dividers with sliding dividers



50735

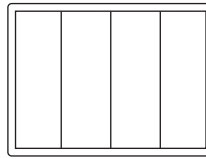

4

_Separadores variables ajustables cada 20mm

_Adjustable cross dividers every 20mm

50740

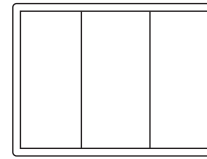

3

_Compartimentos
_Compartment

50745

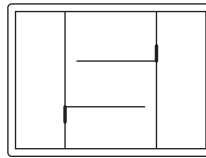

5

_Separadores variables y deslizantes con puntos de rotura cada 10mm

_Adjustable cross divider and flexible sliding dividers with breaking points every 10mm

50750

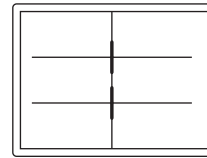

6

_Compartimentos
_Compartment

50755

_Separador ajustable cada 20 mm

_Adjustable cross dividers every 20mm

300 x 100mm

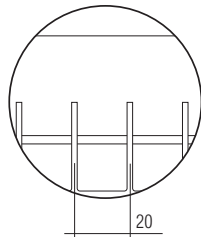
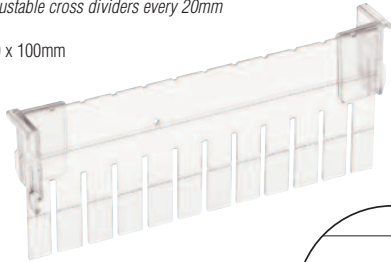

20

50760

_Separador flexible y deslizante con puntos de rotura cada 10mm

_Flexible sliding divider with breaking points every 10mm

170 x 100mm

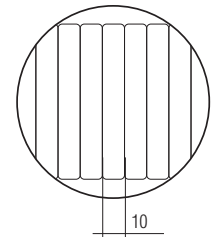
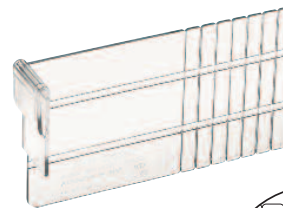

10



_Puedes obtener las medidas que necesitas con solo romper por los puntos de rotura

_To shorten the dividers, just break off the scored sections

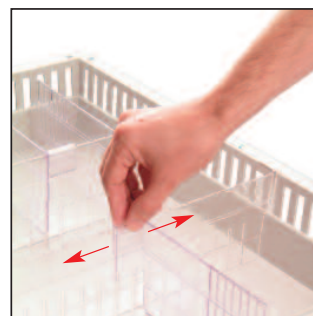
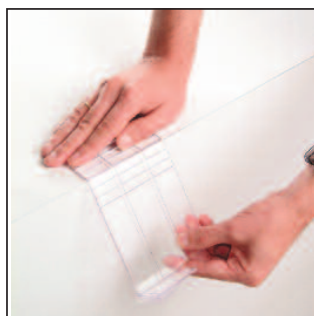

_Los separadores deslizantes son fáciles de cambiar y mover

_The sliding dividers are really easy to move and change

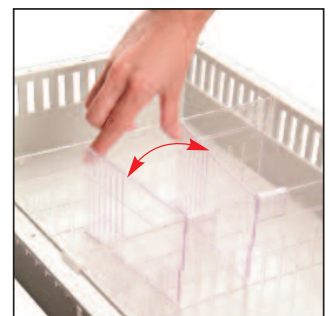



Accesorios para carros hospitalarios multifuncionales
Personalice los carros según sus necesidades

Accessories for multifunctional hospital trolleys
Personalize the trolleys according your needs

50900

_SOPORTE BOTELLA DE OXIGENO \varnothing 110 x 780 mm
_OXYGEN TANK HOLDER \varnothing 110 x 780 mm



50900

_SOPORTE BOTELLA DE OXIGENO \varnothing 140 x 570 mm
_OXYGEN TANK HOLDER \varnothing 140 x 570 mm



50905

_TABLA DE MASAJE CARDIACO
_CARDIAC BACK BOARD



50910

_SOPORTE DE SUEROS, REGULABLE EN ALTURA
_IV DRIP ROD SUPPORT, ADJUSTABLE IN HEIGHT



50915

_SOPORTE CON CAJAS BASCULANTES
_TILT OUT BINS



50920

_CUBO DE PVC
_PVC WASTE BIN



50925

_SOPORTE CON BIOCONTENEDOR DESECHABLE
_SHARP DISPOSAL



50930

_ESTANTE DE 600 x 400 mm
_TRAY OF 600 x 400mm

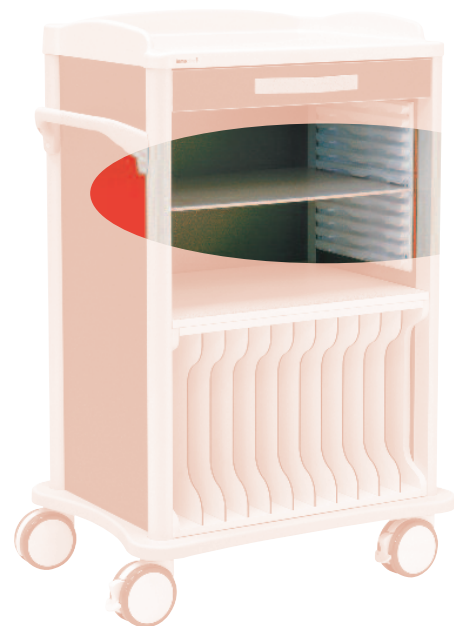

50935

_SOPORTE BRAZO GIRATORIO
_DESFIBRILLATOR MONITOR SHELF

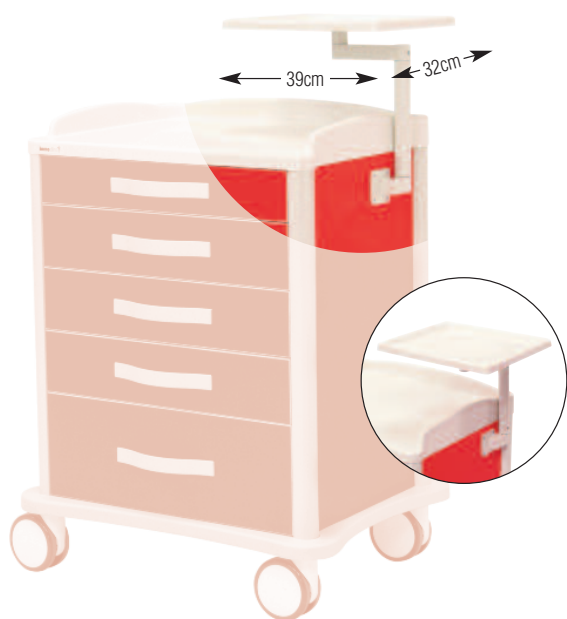

50940

_BANDEJA LATERAL EXTRAIBLE
_LATERAL PULL-OUT SHELF

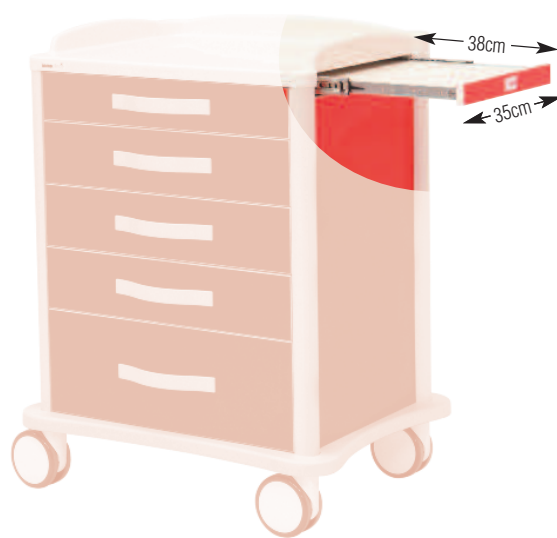

50945

_SOPORTE CON CESTA DE 400 x 300 mm
_SIDE BASKET OF 400 x 300 mm

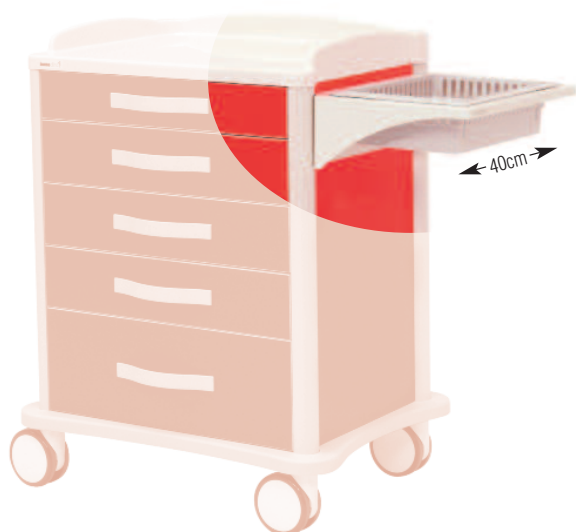

50950

_SOPORTE LATERAL
_SIDE SUPPORT

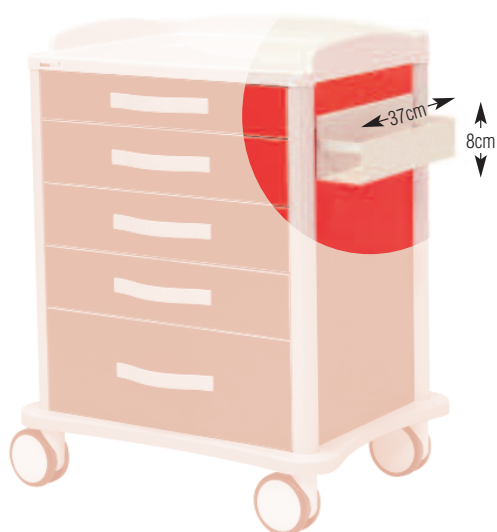

50955

CIERRES CON PRECINTOS DESECHABLES

Incluye 100 precintos

LOCK WITH SECURITY SEAL

Including 100 security seals

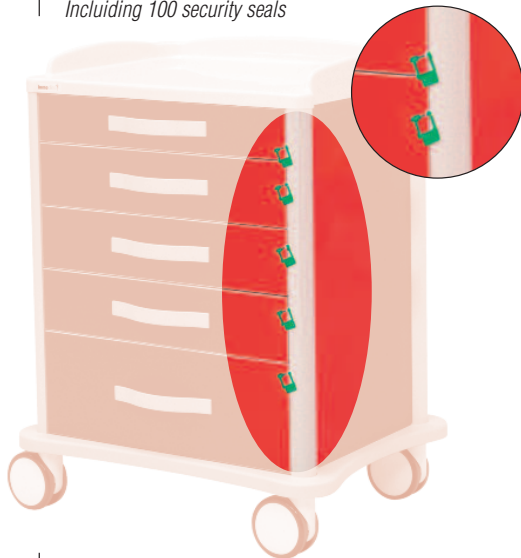

50965

CERRADURA MANUAL CON LLAVE

LOCK WITH KEY

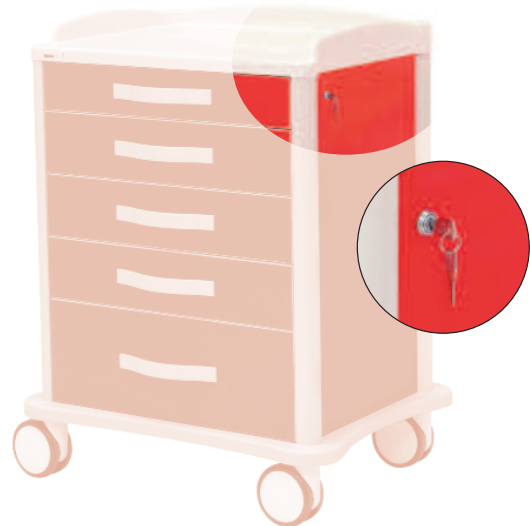

50960



100 PRECINTOS DESECHABLES

100 SECURITY SEALS

50970

BASE DE CONEXION ELECTRICA

BASE WITH MULTIPLE SOCKET PANEL HOLDERS



50975

SOPORTE GUIA CABLES

CABLE GUIDE SUPPORT



50980

_SOPORTE CONTENEDOR DE CATETERES
_CATHETER CONTAINER SUPPORT

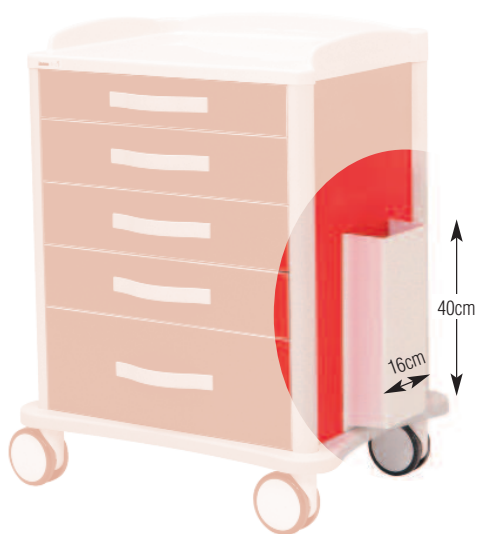

50985

_SOPORTE DOBLE CONTENEDOR DE CATETERES
_DOUBLE CATHETER CONTAINER SUPPORT

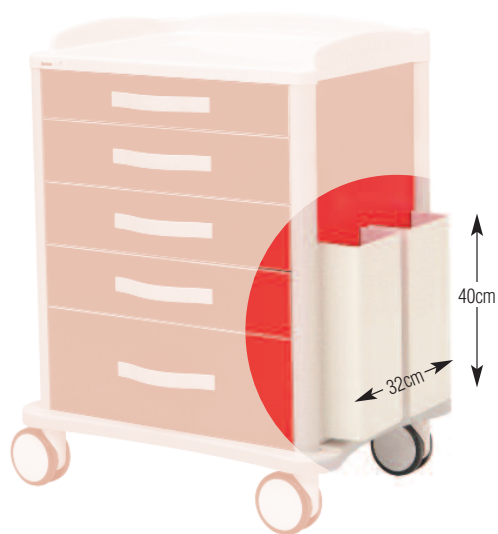

50990

_SOPORTE RIEL DE FIJACION EN TRASERA
_FIXING RAIL ON BACK SIDE



50995

_SOPORTE RIEL DE FIJACION EN LATERAL
_LATERAL FIXING RAIL

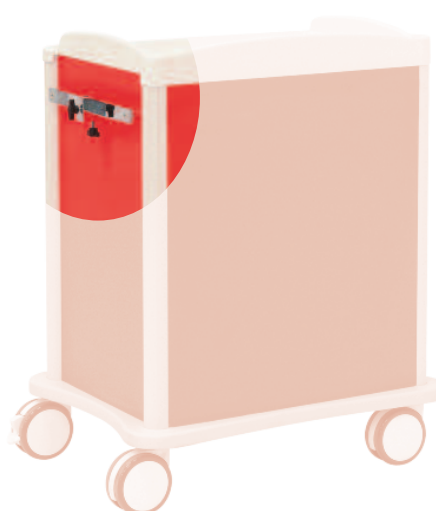

1

_Indique los colores de las patas (1), paneles (2), frentes de cajones (3) y tiradores (4) en la hoja de pedido con su letra correspondiente.
 _No se aceptarán pedidos que no se hagan por medio de la hoja de pedido oficial que les proporcionamos.
 _Indicate the requested colours of the legs (1), panels (2), drawer fronts (3) and handles (4) in your order form with it's corresponding letter.
 _We will not accept orders that are not made in the officially order from that we provide to you.

_Personalice los colores del carro a su gusto.
 _Personalize the colours of the trolley according to your need.

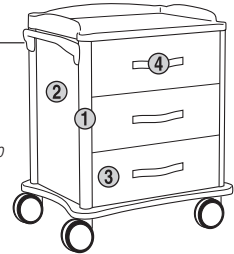

1



2



3



4



_Inoxidable
 _Stainless steel
S

_Azul
 _Blue
B

_Verde
 _Green
G

_Amarillo
 _Yellow
Y

_Naranja
 _Orange
O

_Rojo
 _Red
R

_Beige
 _Beige
W

CARROS
HOSPITALARIOS
MULTIFUNCIONALES

*MULTIFUNCTIONAL
HOSPITAL TROLLEY*

3

C/ Serranía de Cuenca, 10
Pol. Ind. El Olivar
28500 Arganda del Rey (Madrid) Spain
Telf.: 91 872 96 16
91 872 96 17
91 872 96 18
Fax: 91 872 00 40
info@inmoclinc.com
www.inmoclinc.com