



Ancar

DENTAL
INTELLIGENCE
with heart

Since 1958



**Solid
Ergonomic
Reliable**

Series 1

Aluminium Core

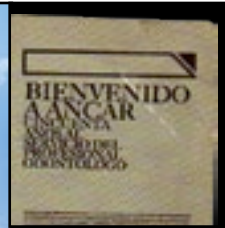

MANUFACTURING TRADITION SINCE 1958.



Ancar
DENTAL
INTELLIGENCE
with hearts



TECHNOLOGY, SERVICE AND ENGAGEMENT.

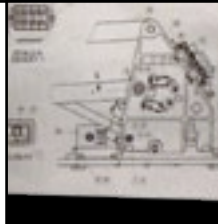

WELCOME TO ANCAR

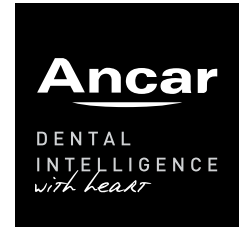

Since 1958

■ Welcome to the world of Ancar where we believe work is about pleasure and joy. Despite the international growth of our company, we have not lost our “family spirit”, nor innovative focus since 1958.

Please join us in our world, where stylish design meets strong and reliable construction. Please enjoy the pleasure of innovation whilst maintaining great value for money.

Please discover the honest and committed after-sales team behind the perfect product.

We love to offer our clients the very best, because we trust the excellent ergonomics and reliability of Ancar ■



Series 1

Aluminium Core



Sd-150

Electro-pneumatic treatment centre
(Whip arm delivery system)



Sd-175

Electro-pneumatic treatment centre
(Hanging hose delivery system)



Sd-25

Orthodontic and hygienist treatment
centre Sd-60 + mobile delivery cart Cd-25



Sd-60

Orthodontic treatment centre



**Solid
Ergonomic
Reliable**



Cd-25

Mobile delivery Cart



Ancar 3200

Ambidextrous chair for
orthodontic treatments



Ancar 3100

Dental Chair with assistants
support



Ancar 3000

Dental chair

NEW

NEW DESIGNS AND STIMULATING INNOVATIONS:
BEAUTY, SIMPLICITY AND DURABILITY.



CUSTOMISED CUSPIDOR COVERS

■ The innovative power and Ancar's continuous improvement in every area of the dental unit, makes it better in ergonomics, hygiene and safety, in order to have a comfortable, safe and reliable intervention ■



'Touch Open' door giving easy access inside the cuspidor.



Narrow backrest (optional).



Removable and autoclavable porcelain cuspidor bowl.



Removable cup filler for easier cleaning.



Progressive pedal.
Electrical control by potentiometer micromotor.

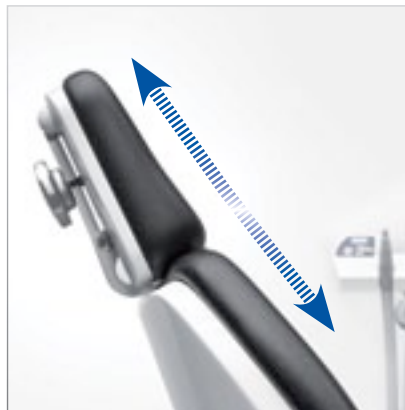

Optional ergonomic headrest, articulated and multipositional for children and adults.



Hydric box made of anticorrosive aluminium and with 70° turn.



Optional auxiliary tray.
Working surface dimension:
400 x 300 mm.

Sd-150

Electro-pneumatic
treatment centre.
(Whip arm delivery
system)

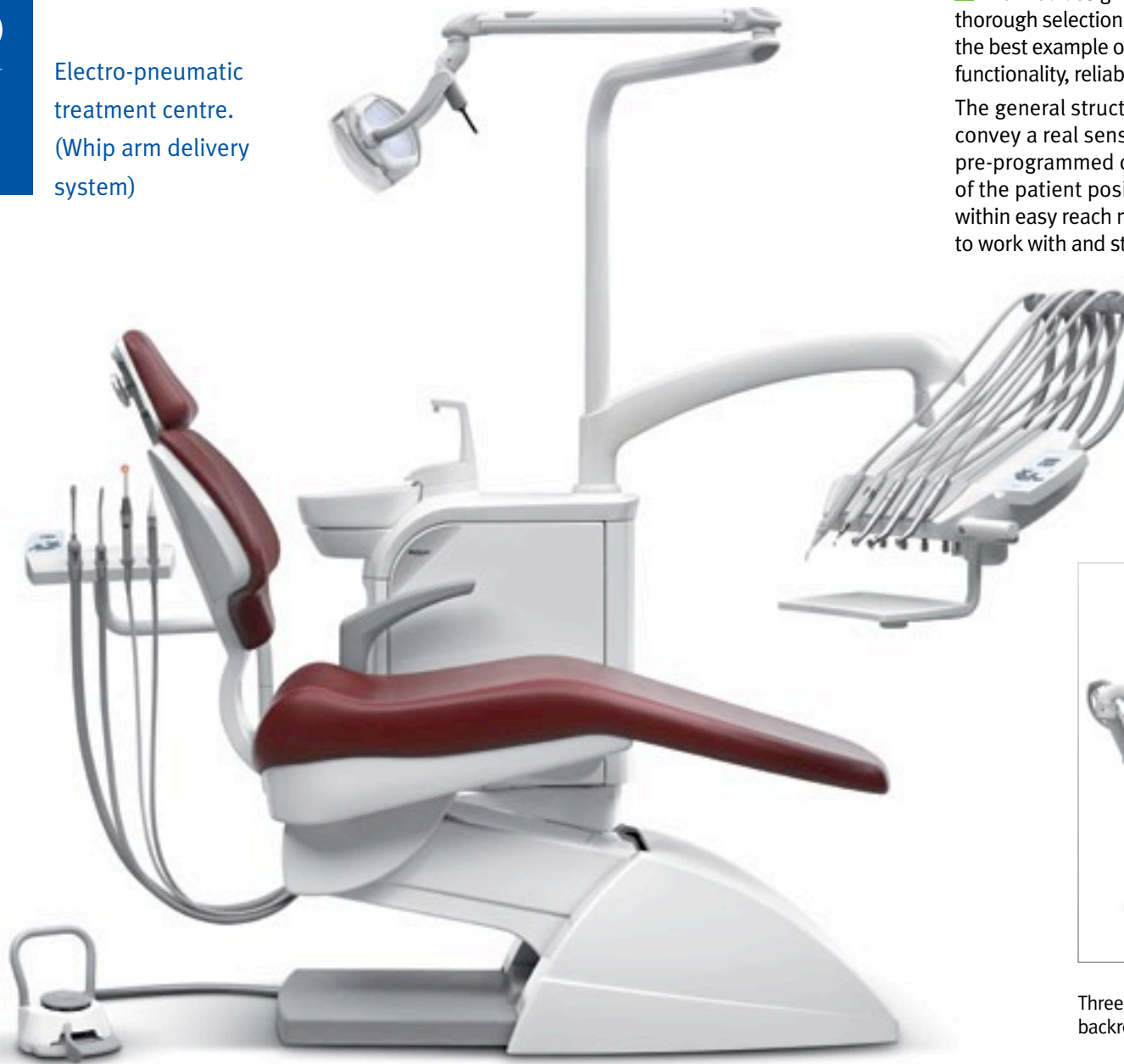

ELEGANT FUNCTIONALITY.

■ A refined design built with sound construction and thorough selection of the finest materials. The Sd-150 is the best example of perfect harmony between functionality, reliability, ergonomics and pure aesthetics. The general structure and the precision of the finish convey a real sense of quality and durability. The five pre-programmed chair positions, the maneuverability of the patient position and with all instruments always within easy reach make the Sd-150 quick and comfortable to work with and still provide easy access to the patient ■



Three safety functions on the assistants support, backrest and chair base.



Wide lifting range from 400 to 810 mm to work standing or seated.



Sd-175

Electro-pneumatic
treatment centre.
(Hanging hose
delivery system)



A “PREMIUM” PRODUCT OF EXCEPTIONAL QUALITY.

■ The Ancar 1 Series is the obvious answer for the dental professional looking for easy access to all of its excellent and intelligent features.

Its adaptability lends itself to all types of dental consultancy and clinics. It is well designed and well constructed and is always ready for easy modification, offering numerous accessories to suit your needs and preferences. The 1 Series promises dentists comfort, performance and reliability; and to their patients that important sense of well being ■



Hanging hose version with two trays for small hand instruments including pneumatic brake for better stability.



Sd-25

Orthodontic and
hygienist treatment
centre Sd-60 +
mobile delivery cart
Cd-25



INTELLIGENT DECISION.

■ The Sd-25 combines the strength and quality of work, which offer the range of Series 1; it also provides a great versatility while finding useful workspaces where other units can not access.

Its great mobility is designed to ensure the maximum adaptability to the consultancy work and to guarantee high work efficiency ■



The Sd-25 assistant's support comes standard with two suction hoses, 3-function syringe and a turbine hose.



Sd-60

Orthodontic
treatment centre



STYLISH ORTHODONTICS.

■ The Sd-60 unit is the simplest but most ingenious way to equip your surgery, especially designed for orthodontic and hygienist practice.

An affordable investment provides an orthodontics unit with the best specifications, quality materials, safety, precision, functionality, ergonomics and hygiene ■

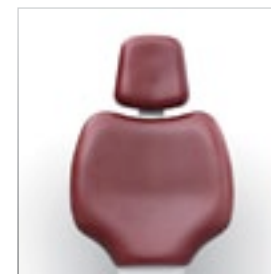

Tight backrest (optional).



Auxiliary Tray "Faro"
(405 x 365 mm).



Cd-25

Mobile delivery Cart

WHEREVER, WHENEVER AND HOWEVER YOU WISH.



Manual height adjustment and wheel lock system.



"Easy Touch" control panel, intuitive and ergonomic.



Junction box and pneumatic independent pedal.



Automatic pneumatic pedal with water selection and "chip blower" system.

Ancar 3200

Ambidextrous chair
for orthodontic
treatments



ORTHODONTICS WITH STYLE.

■ The Ancar 3200 chairs, meets all your needs. The ergonomics of its design allows a wide range of movements whilst considering comfort and safety in any position.

The anti-corrosive aluminium alloys and mechanical reliability make the Ancar dentists chair, a tried and tested product.

Versatility and functionally at the highest level guarantee patients well being for optimum orthodontic treatment ■



Ambidextrous instrument support. 3F Syringe, standard suction hose, turbine and electric micro-motor with/without optional light.



Water regulator and individual spray control for each instrument, micro-motor rotation inversion with speed selector from 0 to 4,000 RPM and from 0 to 40,000 RPM. Also including oil recovery for rotary instruments.



Ancar 3100 Ancar 3000

Dental Chair



Ancar 3100



Chair movement pedal with integrated memories.



Multiposition headrest.



Ancar 3000

COMFORTABLE FOR YOU, COMFORTABLE FOR YOUR PATIENTS.

■ The features of the Ancar 3100 and the Ancar 3000 chairs are exclusive to the dental professional. Our aim is to offer you and your patients the utmost comfort throughout the whole treatment.

All units in the Series 1 are more comfortable, thanks to their two types of covering: "Standard" and "Soft Drive". Its headrest can be adjusted to any height, even for children, allowing for optimum and comfortable working positions. Additionally, all of the positions of both chairs can be adjusted with the pedal. Optionally, an armrest may be added to the right-hand side.

They are equipped with safety devices at the base and backrest to avoid unforeseen movements and to guarantee maximum reliability whilst also offering user safety during required movement.

The finest quality materials coupled with the painstaking devotion to finish gives the Series 1 treatment centres and chairs impeccable aesthetics alongside reliability, longevity and all round satisfaction ■



Chair with trendelenburg position with five pre-programmed position (three for treatments with one reset and one turn to cuspidor). Reclines to a minimum height of 430 mm assisting work to the upper jaw.

DETAILS
THAT
MAKE THE
DIFFERENCE



“Easy Touch” control panel, intuitive and ergonomic.



Balanced arms for effortless use.



Removable and autoclavable instrument support.



Rotary instrument oil collector.



Separate water and spray control valves for each instrument. Micromotor speed selector from 0 to 2,500 RPM (Selective) and from 0 to 40,000 RPM (Global).

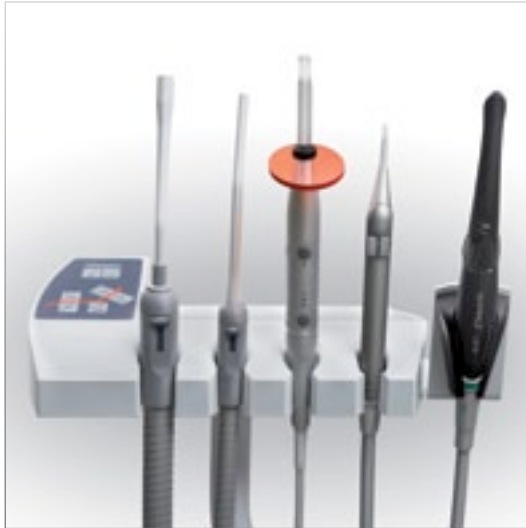

Assistant support with two standard suction hoses. Possibility of installing an optional 3F. inox syringe, intraoral camera and polymerizing lamp.



Multi-function pedal with chair movement control and instrument control using lever, with water and “chip-blower” selector.



ALUMINIUM CORE
Made in light, anticorrosive aluminium alloy.



Main instrument tray and standard auxiliary tray (285 x 190 mm).



Robust build quality and cutting-edge technology.



Excellence in constructive details.

PERSONALIZE
THE UNIT TO
SUIT YOU

New "SELF WATER SYSTEM"



- Independent water supply system for instruments on the equipment.
- The equipment water circuit is designed in order to prevent water returns due to a loss of pressure. Thereby avoiding, the mixture of different water uses, discarding any cross contamination to the public water supply and vice versa.
- This system ensures compliance with regulations EN1717.

DISINFECTION SYSTEMS AND AMALGAM SEPARATION



WEK system for water decontamination instrument hoses. Combined decontamination cycle and automatic water circuits in rotary instruments. Continuous and effective non-toxic decontaminating effect, automatic monitoring of sterile dosage. Maintenance-free operation.



H1 system continuous cleaning and complete disinfection of the suction system. Without need for additional manual disinfection. H1 includes the automatic selection suction hose system.



Built-in amalgam recovery and air and water separation systems with selection valve: dry or wet suction.

LAMPS

The new generation of high-specification lamps with LED technology offer a whole range of benefits:

- LED lights generate a natural quality light which guarantees sharper vision in comparison with halogen light since they offer a greater visual field, fewer shadows during the treatment process and a whiter cold light.
- LED light sources are longer lasting than the halogen bulbs; with minimum heat generated and lower consumption.



TECHNICAL FEATURES	ALYA	MAIA	POLARIS	IRIS	EDI
Technology	LED	LED	LED	LED	halogen
Light source	2 LED's	2 LED's	10 LED's	8 LED's	1 halogen
Colour temperature (°K)	5.000 K	5.000 K	4.200 K to 5.800 K	4.200 K to 6.000 K	5.000 K
Light intensity (lux)	3.000 to 50.000 lux	3.000 to 35.000 lux	8.000 to 35.000 lux	8.000 to 35.000 lux	8.000 to 25.000 lux
Colour rendering index (CRI)	95	85	→ 85	→ 93	95
Illuminated area (mm)	180 x 90	170 x 85	140 x 70	140 x 70	180 x 60
Full HD video camera (pixels)	no	no	no	yes (1,920 x 1,080 px)	no
Power supply	17-24 vac 50/60 hz	17-24 vac 50/60 hz	12-24 vac 50/60 hz	12-24 vac 50/60 hz	17v - 50/60 hz
Consumption	26 W	9 W	29 W	50 W	95 W
Guarantee	24 months	12 months	24 months	12 months	12 months
Certificate according to directive	93/42 CE class I	93/42 CE class I	93/42 CE class I	93/42 CE class I	93/42 CE class I

PERSONALIZE
THE UNIT TO
SUIT YOU

IMAGING SYSTEMS

LCD monitor 17" to 24", high resolution (1280 x 1024). Lasting screen, versatile and high output display with a wide range of integrated video options, designed specifically for dentistry environments. Anti-glare optical crystal. Metal housing.

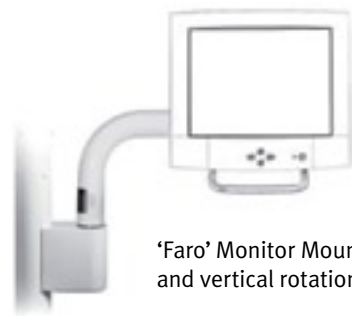

'Faro' Monitor Mount with side and vertical rotation.

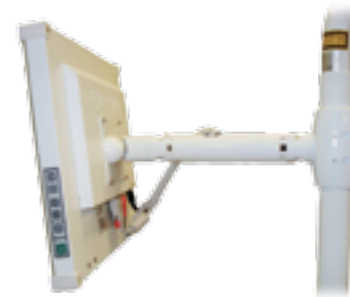

'Start' Monitor Mount.

Wide range of intraoral cameras with integrated systems, ideal for training and motivate patients in all treatment phases. Clear and simple images for immediate use.

BRUSH-FREE INDUCTION MICRO MOTOR

Brushless induction Micromotor with ENDO functions. Programable for contra angle ration, minimum and maximum speed, par, torque, forward/reverse and optic light intensity.

High benefits at high and low speed (from 100 to 40.000 rpm), which allows a wide range of interventions:

- High speed for restoration work.
- Low speed (100 - 4000 rpm) for endodontic.
- Automatic reverse rotation when the selected par is reached.
- Automatic return to counter clockwise (adjustable time delay).
- Autoclavable.
- Light, powerful and quiet.
- Virtually no maintenance.
- Long working life.
- Non-vibrating.



AUXILIARY TRAYS

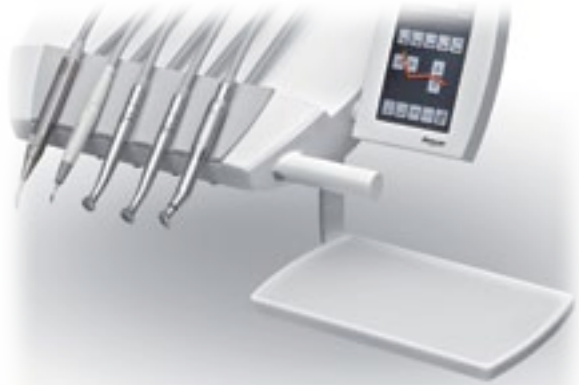

Standard auxiliary tray (285 x 190 mm).



Big auxiliary tray (350 x 230 mm).



Double auxiliary tray (410 x 310 mm).

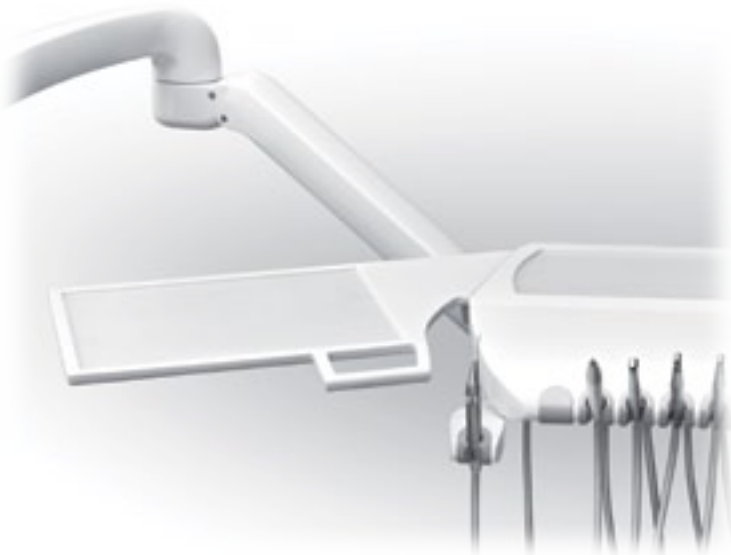

Auxiliary tray (400 x 300 mm) "For hanging hose version".
Additional syringe support is included.



Auxiliary tray "Faro" (405 x 365 mm).

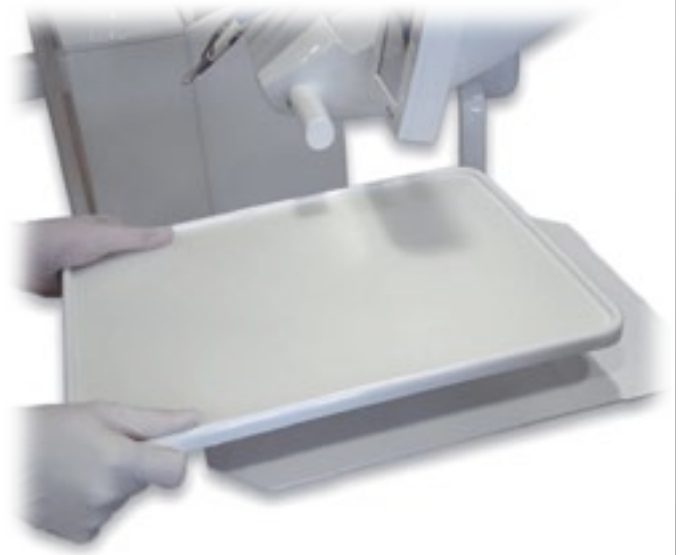

Tray holder with removable silicone protection.

CUSHION FOR CHILDREN



OPTIONAL RIGHT-SIDE ARM

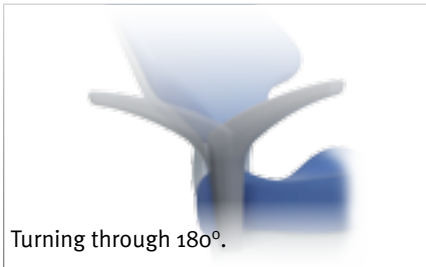

STOOLS



HEADREST AND BACKREST



CUSPIDOR COVER COLOURS



STANDARD RANGE UPHOLSTERY COLOURS



'SOFTDRIVE' UPHOLSTERY COLOURS



TECHNICAL FEATURES

FUNCTIONS

- Electrically-operated chair with trendelenburg and 5 position memories (three for working, reset and return to cuspidor).
- Pedal with chair movement control and instrument control using lever, with water and “chip-blower” selector.
- Micromotor speed selector from 0 to 2,500 RPM (selective) and from 0 to 40,000 RPM (Global).
- Control of individual water flows for each instrument.
- Reversal selection of micromotor and ultrasounds power level.
- ON/OFF supplying water and air to the unit.
- Automatic ON/OFF lamp in rest and return to cuspidor position.
- 3F Syringe installed as standard.
- Optional quick connection Kit: USB 2.0 port built + air/water intake + output 230 V.
- Electric micromotor control by potentiometer.

ERGONOMICS

- Minimum chair height of 400 mm, making treatment of upper areas easier.
- Multi-position articulated headrest.
- Chair movements available on control pedal and keypad (principle and assistant).
- Intuitive and ergonomic “Easy-Touch” control panel, with micromotor reverse indication.
- Arm and instrument tray with mechanical compensation and pneumatic brake.
- Additional tray for small hand instruments.
- Water box with 70° turn to make assistant’s work easier.
- Ergonomic headrest at the same level as the optional backrest.
- Optional tight backrest.

MATERIALS

- ALUMINIUM CORE: unit, chair and pedal manufactured in light anti-corrosive aluminium alloys.
- Water unit covers and connections unit embellisher made from highly resistant and non-deformable special Baydur® polyurethane.
- Large-capacity porcelain cuspidor.
- Standard” and “Soft drive” upholstery, high quality and hygienic, fireproof, steam and air permeable, highly elastic and pleasant feel.

SAFETY FEATURES

- On auxiliary cannula support, backrest and chair base.
- In movement keypads.
- On optional instruments (turbine, micromotor and ultrasound) through adjustor pedal.
- Manufactured according to Health Product Directive 93/42 CEE, design and construction meeting dental product standards EN 1640/ISO 7494, and IEC safety standards.

HYGIENE

- Autoclavable silicone instrument support.
- Dismountable and thermo – disinfectable suction hoses.
- Easy – clean suction filter.
- Rotary instrument oil recuperator.
- Fewer joints and corners, making it easy to clean.
- “WEK” water decontamination system for instrument hoses.
- H1 disinfection system for suction hoses.
- Removable and autoclavable cuspidor at 135°.



DIMENSIONS

Sd-150

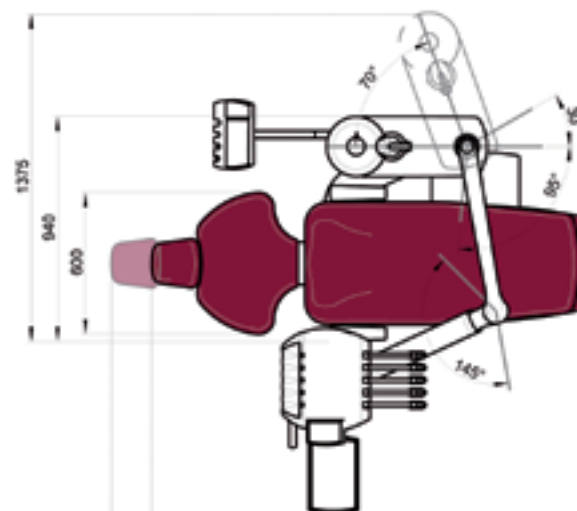
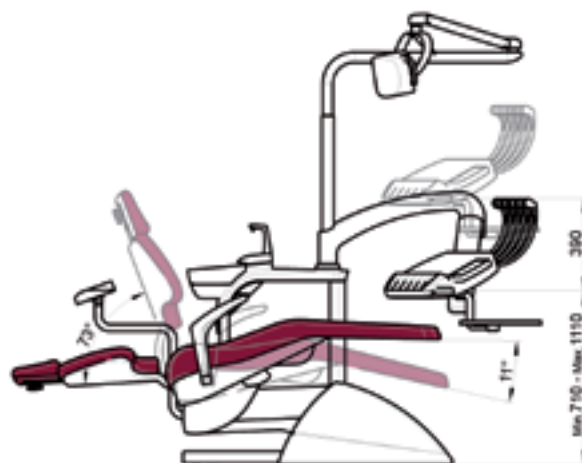

Sd-175

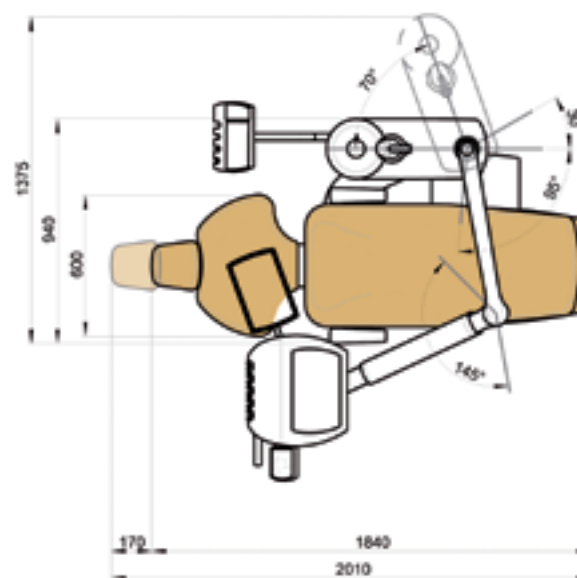
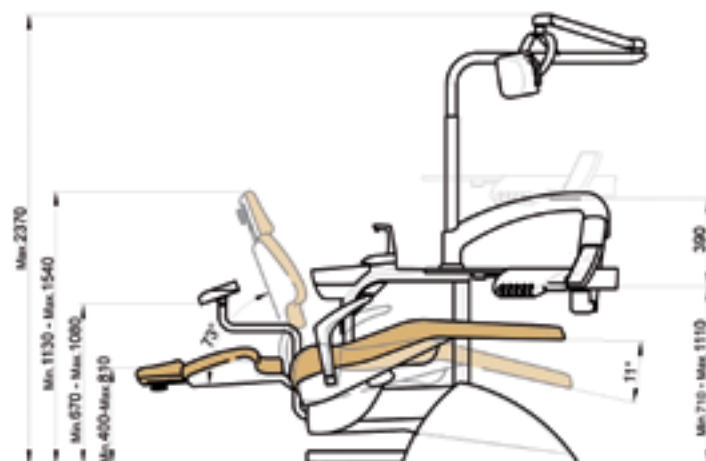

Sd-25 - [Sd-60+Cd-25]

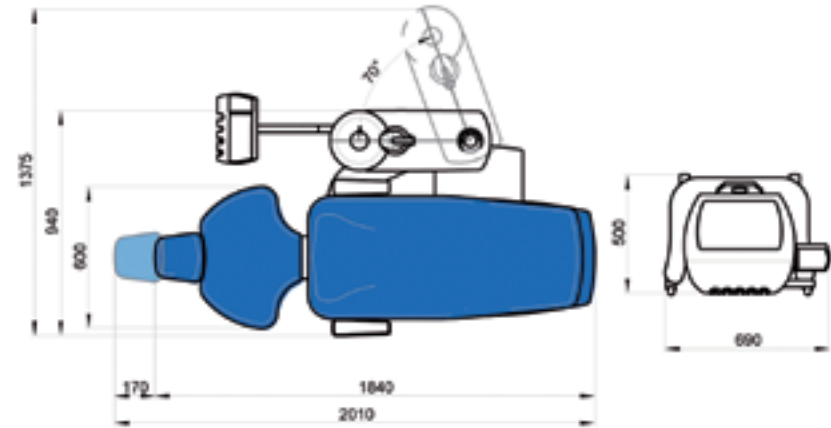
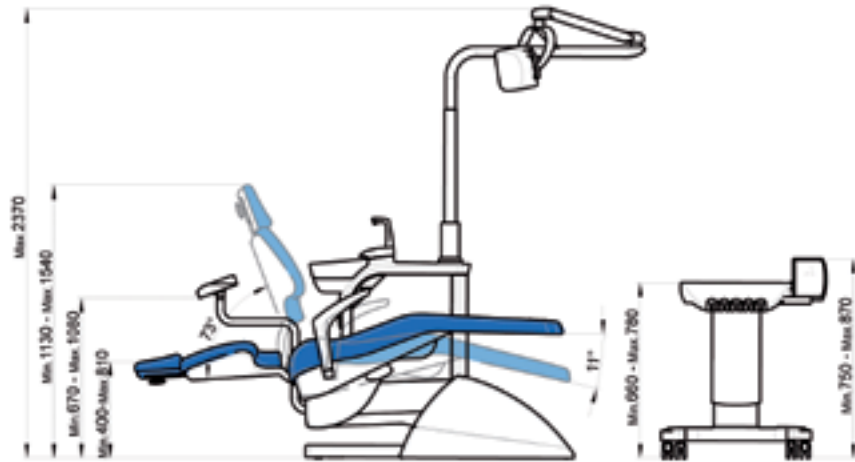

Sd-60

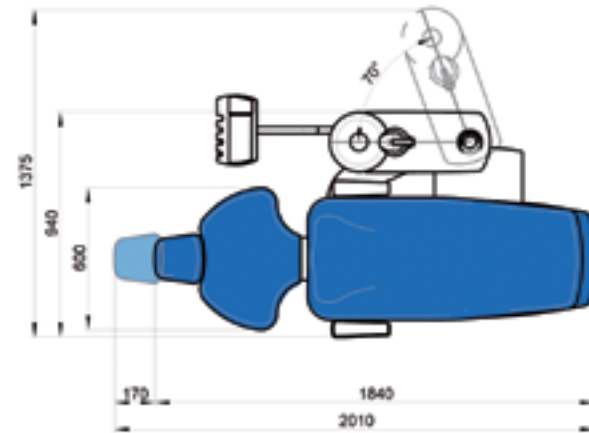
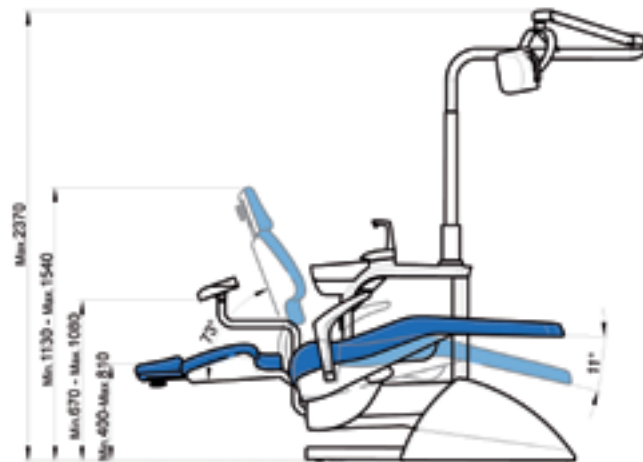

DIMENSIONS

ANCAR 3200

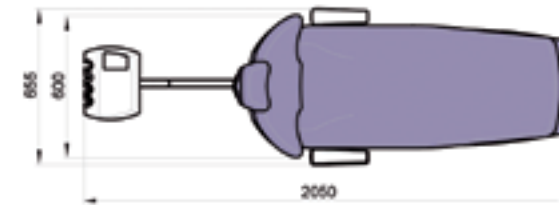

ANCAR 3100

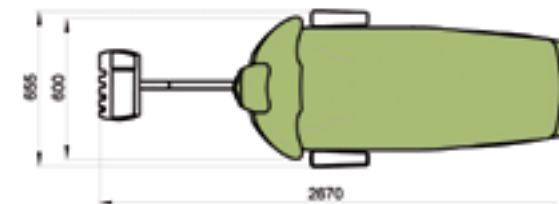

ANCAR 3000

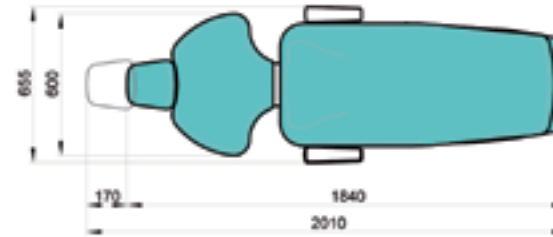

Cd-25

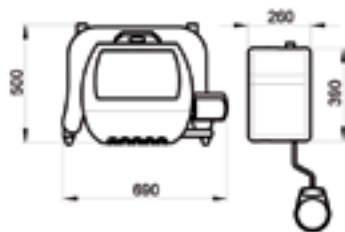

TECHNICAL DATA

Voltage	220 - 240 V~	Unit standard 93/42/EEC	Class IIa
Frequency	50 Hz	Insulation type	Type B
Air pressure	5,5 Bar	Unit net / gross weigh	240 kg / 290 kg
Water pressure	3 Bar	Dental unit type	Electro-pneumatic
Power	900 W	Installation type	Permanent
Electrical protection type	I	Main fuse	6.3 A / 250 V
Operation type	Intermittent	Movement panel fuse	T 32 mA / 250 V
Maximum load (patient)	160 kg	Transform primary fuse, 9015093 PCB	TT 2.5 A / 250 V
Maximum load (instrument tray)	2 kg	24V ac line protection (yellow/yellow)	Polyswitch RUE600
MX Micromotor instrument	24 Vdc / 65 W	17V ac line protection (red/red)	Polyswitch RUE600 + RUE185
MX Micro motor instrument	24 Vdc / 60 W (130 W pico)	Auxiliary outputs 24VCA	4 x Hydric box
Instrument light	3v - 7v / 2.5 W	Aspiration connection	1 x connection box
Ultrasounds	24 Vac / 35 W	Potential free contact AUX connections box	500 W / 230 V Relays 20 A / 250 V
Polymer lamp	24 Vac / 150 W		Max 250 V / 5 A
3F Syringe			

Ancar

DENTAL
INTELLIGENCE
with heart

Since 1958

Other models in the Ancar range:

Series 3



Sd-300 Touch Expert



Sd-300 Scandinavian

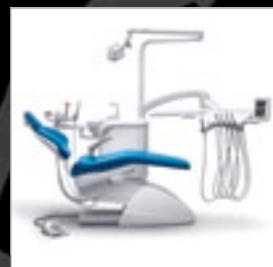

Sd-350 Touch Expert



Sd-80 Touch Expert



Sd-80 Scandinavian

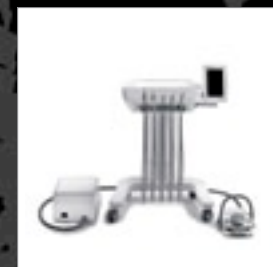

Cd-80 Touch Expert

Series 5

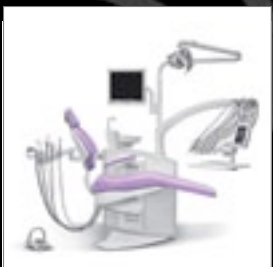

Sd-550 Touch Expert



Sd-575 Touch Expert

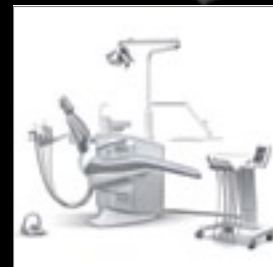

Sd-580 Touch Expert



QS4 LEA 022 V.4

Subject to design and/or specifications changes without prior notice.
Made in Europe. 2nd Edition: October 2014.

Antoni Carles, S.A.

Volta dels Garrofers, 41-42 Polígono Industrial "Els Garrofers"
08340 Vilassar de Mar (Barcelona-SPAIN)
Tel. (34) 93 754 07 97 Fax (34) 93 759 26 04
www.ancar-online.com / e-mail: ancar@ancar-online.com