

# 3

## CARROS HOSPITALARIOS MULTIFUNCIONALES

*MULTIFUNCTIONAL  
HOSPITAL TROLLEY*



ED4

**inmo**clinc 



## in the world



**Calidad  
Quality**



**Medio Ambiente  
Environment**



**Productos Sanitarios  
Medical Devices**



Queda totalmente prohibida la reproducción total o parcial de este catálogo, así como la transmisión y difusión en cualquier soporte o medio mecánico o electrónico, sin el permiso previo de INMOCLINC, S.A.

INMOCLINC, S.A. se reserva el derecho de modificar medidas y/o características de los productos de este catálogo sin previo aviso.

Esta edición sustituye a la anterior.

*It is prohibited the total or partial reproduction of this catalogue, as well as the transmission and diffusion in any support or mechanical or electronic means totally, without the previous permission of INMOCLINC, S.A.*

*INMOCLINC, S.A. reserves the right to make modifications and improvements without previous notice.*

*This edition replaces the previous.*

# Indice

*Index*

4	Carros hospitalarios multifuncionales <i>Cure and urgencies trolley</i>
22	Accesorios <i>Accessories</i>
25	Carros multifuncionales acero inoxidable cajones apertura total <i>Multifunctional Hospital trolley stainless steel total opening drawers</i>
40	Acesorios <i>Accessories</i>
45	Carros multifuncionales Cestas ISO Cestas ISO Modular <i>Multifunctional Hospital trolley baskets ISO Modular</i>
70	Accesorios <i>Accessories</i>

21  
84  
56



**70000**



**CARACTERÍSTICAS TÉCNICAS**

- \_ CARRO HOSPITALARIO MULTIFUNCIONAL
- \_ Estructura de aluminio y acero con revestimiento en epoxy
- \_ Plano superior de ABS con reborde en tres lados
- \_ Empujador lateral
- \_ Base de alto impacto en ABS
- \_ Cajones apertura 110%, frentes colores: rojo, azul, morado y pistacho
- \_ Guías telescópicas con autocierre
- \_ Ruedas de 100mm, dos de ellas con freno
- \_ Equipados opcionalmente con accesorios (ver páginas 22 a 24)





**70005**



- \_ Bandeja inferior en ABS
- \_ ABS lower shelf

**TECHNICAL CHARACTERISTICS**

- \_ MULTIFUNCTIONAL HOSPITAL TROLLEY
- \_ Aluminium and epoxy steel coating structure
- \_ ABS upper top with extended up rims on three sides
- \_ Lateral push handle
- \_ High impact ABS base
- \_ 110% total opening drawers, front of the drawers in colours: red, blue, purple and light green
- \_ Telescopic slides with automatic shutting system
- \_ 100mm rolling wheels, two with brakes
- \_ Equipped with optional accessories (see pages 22 to 24)

					
<b>70000</b>	65	56	94	24	0,34
<b>70005</b>	65	56	94	25	0,34



**70005**  
+ 70235

**CARACTERÍSTICAS TÉCNICAS**

- \_ CARRO DE ANESTESIA
- \_ Estructura de aluminio y acero con revestimiento en epoxy
- \_ Plano superior de ABS con reborde en tres lados
- \_ Empujador lateral
- \_ Base de alto impacto en ABS
- \_ Cajones apertura 110%, frentes colores: rojo, azul, morado y pistacho
- \_ Guías telescópicas con autocierre
- \_ Ruedas de 100mm, dos de ellas con freno
- \_ Equipados con accesorios:
- Ref.70235** Soporte para ordenador portátil (ver páginas 22 a 24)

**TECHNICAL CHARACTERISTICS**

- \_ ANAESTHESIA TROLLEY
- \_ Aluminium and epoxy steel coating structure
- \_ ABS upper top with extended up rims on three sides
- \_ Lateral push handle
- \_ High impact ABS base
- \_ 110% total opening drawers, front of the drawers in colours: red, blue, purple and light green
- \_ Telescopic slides with automatic shutting system
- \_ 100mm rolling wheels, two with brakes
- \_ Equipped with accessories:
- Ref.70235** Laptop support (see pages 22 to 24)

Colores | Colours

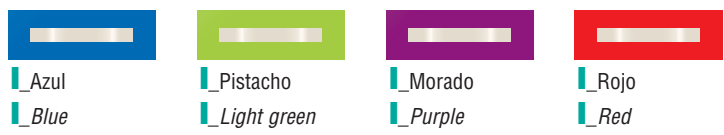



**70010**



**CARACTERÍSTICAS TÉCNICAS**

- \_ CARRO HOSPITALARIO MULTIFUNCIONAL
- \_ Estructura de aluminio y acero con revestimiento en epoxy
- \_ Plano superior de ABS con reborde en tres lados
- \_ Empujador lateral
- \_ Base de alto impacto en ABS
- \_ Cajones apertura 110%, frentes colores: rojo, azul, morado y pistacho
- \_ Guías telescópicas con autocierre
- \_ Ruedas de 100mm, dos de ellas con freno
- \_ Equipados opcionalmente con accesorios (ver páginas 22 a 24)





**70015**

- \_ Bandeja inferior en ABS
- \_ ABS lower shelf



**TECHNICAL CHARACTERISTICS**

- \_ MULTIFUNCTIONAL HOSPITAL TROLLEY
- \_ Aluminium and epoxy steel coating structure
- \_ ABS upper top with extended up rims on three sides
- \_ Lateral push handle
- \_ High impact ABS base
- \_ 110% total opening drawers, front of the drawers in colours: red, blue, purple and light green
- \_ Telescopic slides with automatic shutting system
- \_ 100mm rolling wheels, two with brakes
- \_ Equipped with optional accessories (see pages 22 to 24)

					
<b>70010</b>	65	56	94	30	0,34
<b>70015</b>	65	56	94	31	0,34



**70015**

- + 70215
- + 70220
- + 70225

**\_CARACTERÍSTICAS TÉCNICAS**

- \_CARRO DE ANESTESIA
- \_Estructura de aluminio y acero con revestimiento en epoxy
- \_Plano superior de ABS con reborde en tres lados
- \_Empujador lateral
- \_Base de alto impacto en ABS
- \_Cajones apertura 110%, frentes colores: rojo, azul, morado y pistacho
- \_Guías telescópicas con autocierre
- \_Ruedas de 100mm, dos de ellas con freno
- \_Equipados con accesorios:
- Ref.70215** Soporte cajas basculantes
- Ref.70220** Soporte cubo PVC
- Ref.70225** Soporte biocontenedor  
(ver páginas 22 a 24)

**\_TECHNICAL CHARACTERISTICS**

- \_ANAESTHESIA TROLLEY
- \_Aluminium and epoxy steel coating structure
- \_ABS upper top with extended up rims on three sides
- \_Lateral push handle
- \_High impact ABS base
- \_110% total opening drawers, front of the drawers in colours: red, blue, purple and light green
- \_Telescopic slides with automatic shutting system
- \_100mm rolling wheels, two with brakes
- \_Equipped with accessories:
- Ref.70215** Tilt out bins support
- Ref.70220** PVC waste bin
- Ref.70225** Sharp disposal  
(see pages 22 to 24)

Colores | Colours





**70020**



**CARACTERÍSTICAS TÉCNICAS**

- \_ CARRO HOSPITALARIO MULTIFUNCIONAL
- \_ Estructura de aluminio y acero con revestimiento en epoxy
- \_ Plano superior de ABS con reborde en tres lados
- \_ Empujador lateral
- \_ Base de alto impacto en ABS
- \_ Cajones apertura 110%, frentes colores: rojo, azul, morado y pistacho
- \_ Guías telescópicas con autocierre
- \_ Ruedas de 100mm, dos de ellas con freno
- \_ Equipados opcionalmente con accesorios (ver páginas 22 a 24)





**70025**



- \_ Bandeja inferior en ABS
- \_ ABS lower shelf

**TECHNICAL CHARACTERISTICS**

- \_ MULTIFUNCTIONAL HOSPITAL TROLLEY
- \_ Aluminium and epoxy steel coating structure
- \_ ABS upper top with extended up rims on three sides
- \_ Lateral push handle
- \_ High impact ABS base
- \_ 110% total opening drawers, front of the drawers in colours: red, blue, purple and light green
- \_ Telescopic slides with automatic shutting system
- \_ 100mm rolling wheels, two with brakes
- \_ Equipped with optional accessories (see pages 22 to 24)

					
<b>70020</b>	65	56	94	36	0,34
<b>70025</b>	65	56	94	37	0,34





**70020**

+ 70220  
+ 70240

**\_CARACTERÍSTICAS TÉCNICAS**

- \_CARRO DE CURAS
- \_Estructura de aluminio y acero con revestimiento en epoxy
- \_Plano superior de ABS con reborde en tres lados
- \_Empujador lateral
- \_Base de alto impacto en ABS
- \_Cajones apertura 110%, frentes colores: rojo, azul, morado y pistacho
- \_Guías telescópicas con autocierre
- \_Ruedas de 100mm, dos de ellas con freno
- \_Equipados con accesorios:

**Ref. 70220** Soporte cubo PVC

**Ref. 70240** Soporte dispensador de jabón  
(ver páginas 22 a 24)

**\_TECHNICAL CHARACTERISTICS**

- \_CURE TROLLEY
- \_Aluminium and epoxy steel coating structure
- \_ABS upper top with extended up rims on three sides
- \_Lateral push handle
- \_High impact ABS base
- \_110% total opening drawers, front of the drawers in colours: red, blue, purple and light green
- \_Telescopic slides with automatic shutting system
- \_100mm rolling wheels, two with brakes
- \_Equipped with accessories:

**Ref. 70220** PVC waste bin

**Ref. 70240** Sanitizer dispenser support  
(see pages 22 to 24)

Colores | Colours



\_Azul  
\_Blue



\_Pistacho  
\_Light green



\_Morado  
\_Purple



\_Rojo  
\_Red



**CARACTERÍSTICAS TÉCNICAS**

- \_ CARRO HOSPITALARIO MULTIFUNCIONAL
- \_ Estructura de aluminio y acero con revestimiento en epoxy
- \_ Plano superior de ABS con reborde en tres lados
- \_ Empujador lateral
- \_ Base de alto impacto en ABS
- \_ Cajones apertura 110%, frentes colores: rojo, azul, morado y pistacho
- \_ Guías telescópicas con autocierre
- \_ Ruedas de 100mm, dos de ellas con freno
- \_ Equipados opcionalmente con accesorios (ver páginas 22 a 24)

70030



**TECHNICAL CHARACTERISTICS**

- \_ MULTIFUNCTIONAL HOSPITAL TROLLEY
- \_ Aluminium and epoxy steel coating structure
- \_ ABS upper top with extended up rims on three sides
- \_ Lateral push handle
- \_ High impact ABS base
- \_ 110% total opening drawers, front of the drawers in colours: red, blue, purple and light green
- \_ Telescopic slides with automatic shutting system
- \_ 100mm rolling wheels, two with brakes
- \_ Equipped with optional accessories (see pages 22 to 24)

<b>70030</b>	65	56	94	36	0,34



**70030**

- + 70200
- + 70205
- + 70210
- + 70230

**CARACTERÍSTICAS TÉCNICAS**

- \_CARRO DE EMERGENCIAS
- \_Estructura de aluminio y acero con revestimiento en epoxy
- \_Plano superior de ABS con reborde en tres lados
- \_Empujador lateral
- \_Base de alto impacto en ABS
- \_Cajones apertura 110%, frentes colores: rojo, azul, morado y pistacho
- \_Guías telescópicas con autocierre
- \_Ruedas de 100mm, dos de ellas con freno
- \_Equipados con accesorios:
  - Ref.70200** Soporte botella de oxígeno
  - Ref.70205** Tabla de masaje cardiaco
  - Ref.70210** Soporte suero regulable en altura
  - Ref.70230** Cierre con precintos desechables (ver páginas 22 a 24)

**TECHNICAL CHARACTERISTICS**

- \_EMERGENCY TROLLEY
- \_Aluminium and epoxy steel coating structure
- \_ABS upper top with extended up rims on three sides
- \_Lateral push handle
- \_High impact ABS base
- \_110% total opening drawers, front of the drawers in colours: red, blue, purple and light green
- \_Telescopic slides with automatic shutting system
- \_100mm rolling wheels, two with brakes
- \_Equipped with accessories:
  - Ref.70200** Oxygen tank holder
  - Ref.70205** Cardiac board
  - Ref.70210** IV drip rod support, adjustable in height
  - Ref.70230** Lock with security seal (see pages 22 to 24)

Colores | Colours

- |   |   |   |   |
|---|---|---|---|
|  |  |  |  |
| _Azul   | _Pistacho   | _Morado   | _Rojo   |
| _Blue   | _Light green  | _Purple   | _Red  |



**70040**

- \_Bandejas en ABS
- \_Un cajón inferior

- \_ABS shelves
- \_Lower drawer



**CARACTERÍSTICAS TÉCNICAS**

- \_CARRO HOSPITALARIO MULTIFUNCIONAL
- \_Estructura de aluminio y acero con revestimiento en epoxy
- \_Plano superior de ABS con reborde en tres lados
- \_Empujador lateral
- \_Base de alto impacto en ABS
- \_Cajones apertura 110%, frentes colores: rojo, azul, morado y pistacho
- \_Guías telescópicas con autocierre
- \_Ruedas de 100mm, dos de ellas con freno
- \_Equipados opcionalmente con accesorios (ver páginas 22 a 24)

**70045**

- \_Bandejas en ABS

- \_ABS shelves







**TECHNICAL CHARACTERISTICS**

- \_ MULTIFUNCTIONAL HOSPITAL TROLLEY
- \_ Aluminium and epoxy steel coating structure
- \_ ABS upper top with extended up rims on three sides
- \_ Lateral push handle
- \_ High impact ABS base
- \_ 110% total opening drawers, front of the drawers in colours: red, blue, purple and light green
- \_ Telescopic slides with automatic shutting system
- \_ 100mm rolling wheels, two with brakes
- \_ Equipped with optional accessories (see pages 22 to 24)

**70035**

- \_ Bandejas en ABS
- \_ Un cajón superior
- \_ ABS shelves
- \_ Upper drawer



					
<b>70035</b>	65	56	94	26	0,34
<b>70040</b>	65	56	94	26	0,34
<b>70045</b>	65	56	94	18	0,34

Colores | Colours





			
_Azul _Blue	_Pistacho _Light green	_Morado _Purple	_Rojo _Red



**70055**

- \_Bandejas en ABS
- \_Un cajón superior
- \_ABS shelves
- \_Upper drawer



	 cm	 cm	 cm	 KG	 m <sup>3</sup>
<b>70050</b>	65	56	128	28	0,46
<b>70055</b>	65	56	128	27	0,46
<b>70060</b>	65	56	128	20	0,46

**70060**

- \_Bandejas en ABS
- \_ABS shelves



**CARACTERÍSTICAS TÉCNICAS**

- \_CARRO HOSPITALARIO MULTIFUNCIONAL
- \_Estructura de aluminio y acero con revestimiento en epoxy
- \_Plano superior de ABS con reborde en tres lados
- \_Empujador lateral
- \_Base de alto impacto en ABS
- \_Cajones apertura 110%, frentes colores: rojo, azul, morado y pistacho
- \_Guías telescópicas con autocierre
- \_Ruedas de 100mm, dos de ellas con freno
- \_Equipados opcionalmente con accesorios (ver páginas 22 a 24)



\_Mesa escritorio extraíble  
\_Sliding out writing desk

**70050**

- \_Bandejas en ABS
- \_Un cajón superior
- \_ABS shelves
- \_Upper drawer



**TECHNICAL CHARACTERISTICS**

- \_MULTIFUNCTIONAL HOSPITAL TROLLEY
- \_Aluminium and epoxy steel coating structure
- \_ABS upper top with extended up rims on three sides
- \_Lateral push handle
- \_High impact ABS base
- \_110% total opening drawers, front of the drawers in colours: red, blue, purple and light green
- \_Telescopic slides with automatic shutting system
- \_100mm rolling wheels, two with brakes
- \_Equipped with optional accessories (see pages 22 to 24)

Colores | Colours





**70070**

- \_Un cajón
- \_One drawer



- \_Ruedas de 80mm color único Gris
- \_80mm rolling wheels, only grey colour

**CARACTERÍSTICAS TÉCNICAS**

- \_CARRO HOSPITALARIO MULTIFUNCIONAL
- \_Estructura de aluminio y acero inoxidable
- \_Bandejas superior e inferior extraíbles en acero inoxidable
- \_Base de alto impacto en ABS
- \_Cajones, frentes colores: rojo, azul, morado y pistacho
- \_Ruedas de 80mm
- \_Equipados opcionalmente con accesorios (ver páginas 22 a 24)

**70075**

- \_Dos cajones
- \_Two drawers



- \_Ruedas de 80mm color único Gris
- \_80mm rolling wheels, only grey colour

**TECHNICAL CHARACTERISTICS**



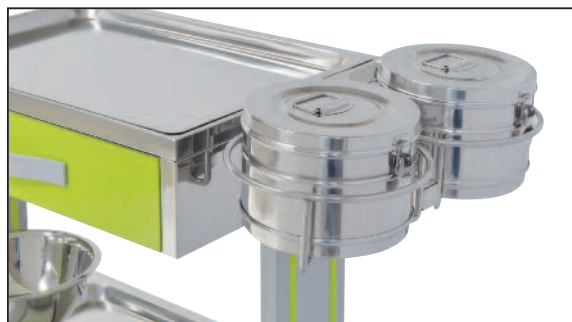

- \_MULTIFUNCTIONAL HOSPITAL TROLLEY
- \_Aluminium and stainless steel structure
- \_Removable stainless steel upper and lower shelves
- \_High impact ABS base
- \_Front of the drawers in colours: red, blue, purple and light green
- \_80mm rolling wheels
- \_Equipped with optional accessories (see pages 22 to 24)





**\_OPCIONAL:**  
**Ref. 70250**  
Soporte y bombonas porta curas

**\_OPTIONAL:**  
**Ref. 70250**  
Gauze basins and support

					
<b>70065</b>	76	45	86	22	0,30
<b>70070</b>	76	45	86	22	0,30
<b>70075</b>	76	45	86	22	0,30

**70065**

\_ Soporte cubo P.V.C.  
\_ Soporte palangana  
  
\_ P.V.C. waste bin  
\_ Basin Holder



\_ Ruedas de 80mm color único Gris

\_ 80mm rolling wheels, only grey colour

Colores | Colours

			
_Azul _Blue	_Pistacho _Light green	_Morado _Purple	_Rojo _Red



**70085**

- \_Tres bandejas extraíbles
- \_Dos cajones
- \_Ref. 70250 \_Soporte cubo P.V.C.
- \_Three removable shelves
- \_Two drawers
- \_Ref. 70250 \_P.V.C. waste bin



- \_Ruedas de 80mm color único Gris
- \_80mm rolling wheels, only grey colour

**CARACTERÍSTICAS TÉCNICAS**

- \_CARRO HOSPITALARIO MULTIFUNCIONAL
- \_Estructura de aluminio y acero inoxidable
- \_Bandejas superior e inferior extraíbles en acero inoxidable
- \_Base de alto impacto en ABS
- \_Cajones, frentes colores: rojo, azul, morado y pistacho
- \_Ruedas de 80mm
- \_Equipados opcionalmente con accesorios (ver páginas 22 a 24)

**70090**





- \_Dos bandejas extraíbles
- \_Two removable shelves



- \_Ruedas de 80mm color único Gris
- \_80mm rolling wheels, only grey colour

**TECHNICAL CHARACTERISTICS**

- \_MULTIFUNCTIONAL HOSPITAL TROLLEY
- \_Aluminium and stainless steel structure
- \_Removable stainless steel upper and lower shelves
- \_High impact ABS base
- \_Front of the drawers in colours: red, blue, purple and light green
- \_80mm rolling wheels
- \_Equipped with optional accessories (see pages 22 to 24)

					
<b>70080</b>	90	45	94	43	0,38
<b>70085</b>	90	45	86	30	0,38
<b>70090</b>	76	45	86	20	0,30

70080



**CARACTERÍSTICAS TÉCNICAS**

- \_ CARRO HOSPITALARIO MULTIFUNCIONAL
- \_ Estructura de aluminio y acero con revestimiento en epoxy
- \_ Plano superior de ABS con reborde en tres lados
- \_ Empujador lateral
- \_ Base de alto impacto en ABS
- \_ Cajones apertura 110%, frentes colores: rojo, azul, morado y pistacho
- \_ Guías telescópicas con autocierre
- \_ Tres cestas acero inoxidable de 37x28x9cm
- \_ Ruedas de 100mm, dos de ellas con freno
- \_ Equipados opcionalmente con accesorios (ver páginas 22 a 24)

**TECHNICAL CHARACTERISTICS**

- \_ MULTIFUNCTIONAL HOSPITAL TROLLEY
- \_ Aluminium and epoxy steel coating structure
- \_ ABS upper top with extended up rims on three sides
- \_ Lateral push handle
- \_ High impact ABS base
- \_ 110% total opening drawers, front of the drawers in colours: red, blue, purple and light green
- \_ Telescopic slides with automatic shutting system
- \_ 3 stainless steel baskets 37x28x9cm
- \_ 100mm rolling wheels, two with brakes
- \_ Equipped with optional accessories (see pages 22 to 24)

Colores | Colours





**70115**



**CARACTERÍSTICAS TÉCNICAS**

- \_ CARRO HOSPITALARIO MULTIFUNCIONAL
- \_ Estructura de aluminio y acero con revestimiento en epoxy
- \_ Entrepañó superior tablero de fibra recubierto en melamina
- \_ Entrepañó inferior en acero con revestimiento en epoxy
- \_ Base de alto impacto en ABS
- \_ Ruedas de 100mm, dos de ellas con freno





**TECHNICAL CHARACTERISTICS**

- \_ MULTIFUNCTIONAL HOSPITAL TROLLEY
- \_ Aluminium and epoxy steel coating structure
- \_ Upper MDF board laminate
- \_ Epoxy steel coating lower shelf
- \_ High impact ABS base
- \_ 100mm rolling wheels, two with brakes

**70110**

- \_ Un cajón
- \_ One drawer



					
<b>70110</b>	90	45	102	30	0,41
<b>70115</b>	90	45	102	21	0,41

**70100**

- \_Tres cestas 60 x 40 x 10cm
- \_Three baskets 60 x 40 x 10cm

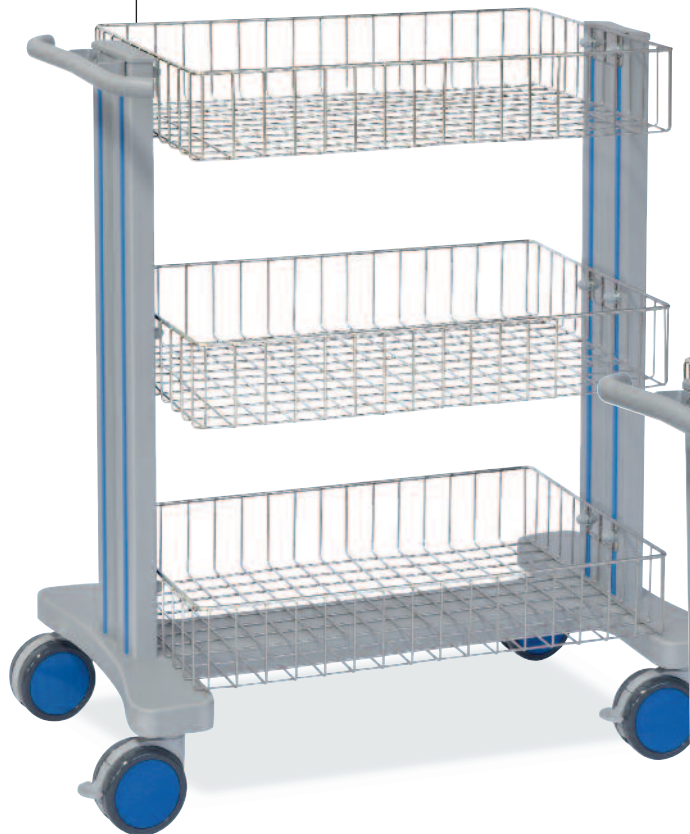

**CARACTERÍSTICAS TÉCNICAS**

- \_CARRO HOSPITALARIO MULTIFUNCIONAL
- \_Estructura de aluminio y acero inoxidable
- \_Cestas acero inoxidable
- \_Base de alto impacto en ABS
- \_Ruedas de 100mm, dos de ellas con freno
- \_Equipados opcionalmente con accesorios (ver páginas 22 a 24)



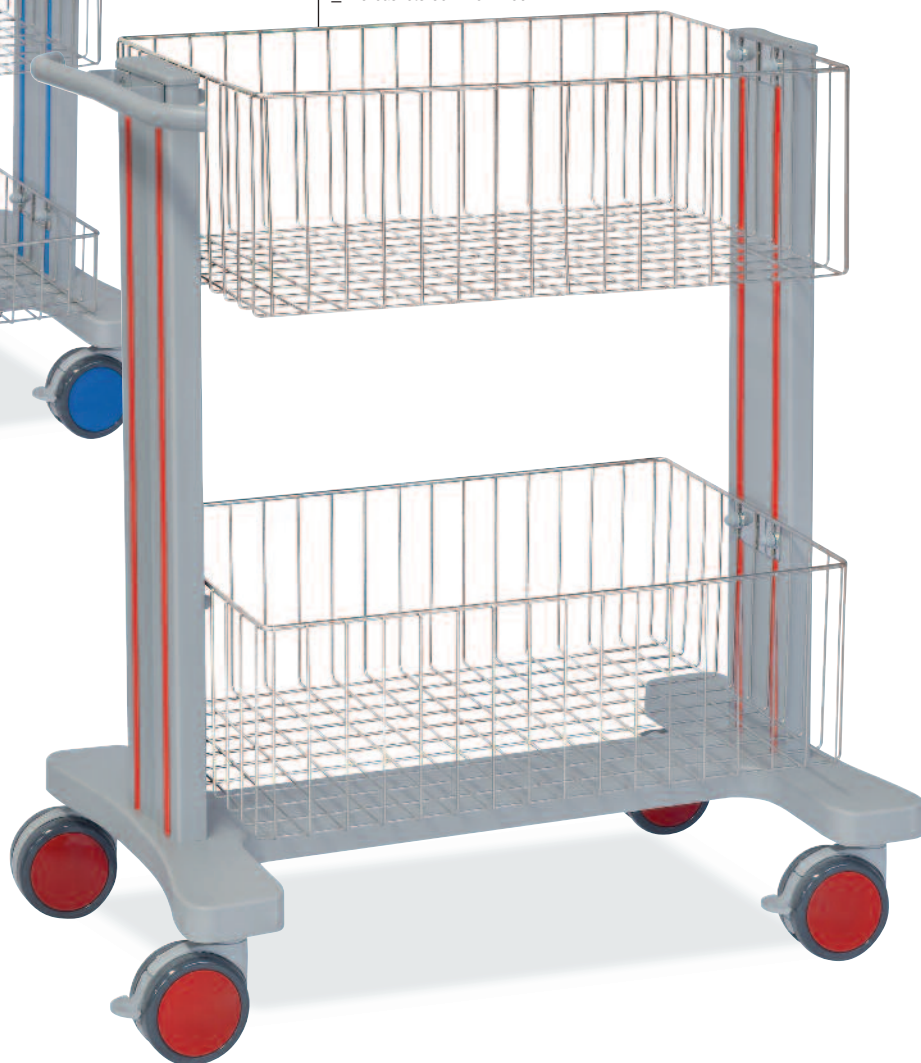

**70105**

- \_Dos cestas 60 x 40 x 20cm
- \_Two baskets 60 x 40 x 20cm



**TECHNICAL CHARACTERISTICS**

- \_MULTIFUNCTIONAL HOSPITAL TROLLEY
- \_Aluminium and stainless steel structure
- \_Stainless steel baskets
- \_High impact ABS base
- \_100mm rolling wheels, two with brakes
- \_Equipped with optional accessories (see pages 22 to 24)

					
<b>70100</b>	77	45	87	16	0,30
<b>70105</b>	77	45	87	16	0,30

Colores | Colours





**70200**

**SOPORTE BOTELLA DE OXIGENO  $\varnothing$ 110x780mm**  
**OXYGEN TANK HOLDER  $\varnothing$ 110x780mm**

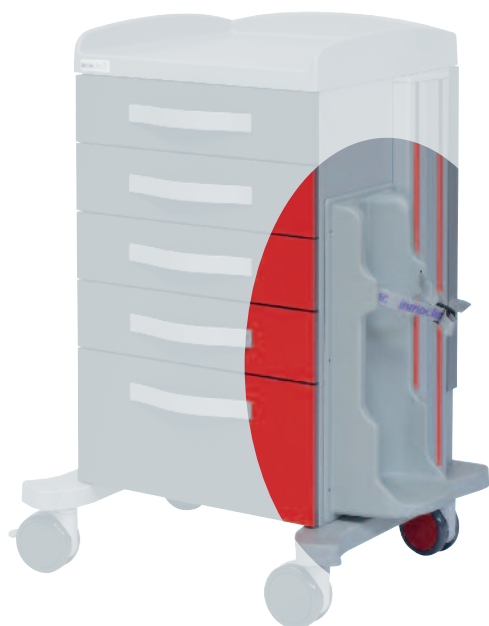

**70200**

**SOPORTE BOTELLA DE OXIGENO  $\varnothing$ 140x570mm**  
**OXYGEN TANK HOLDER  $\varnothing$ 140x570mm**

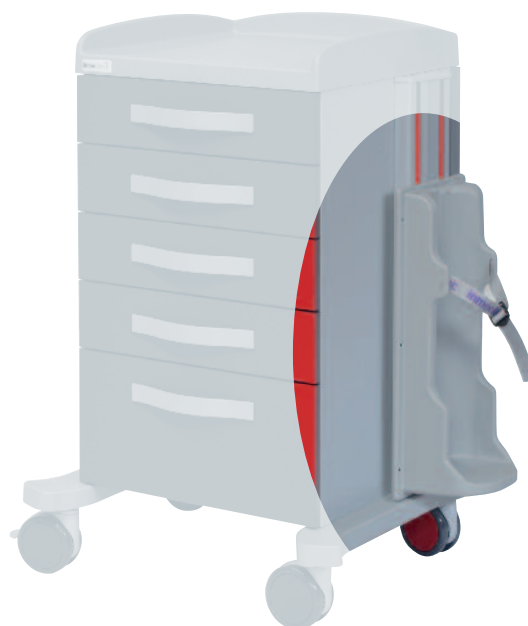

**70205**

**TABLA DE MASAJE CARDIACO**  
**CARDIAC BOARD**

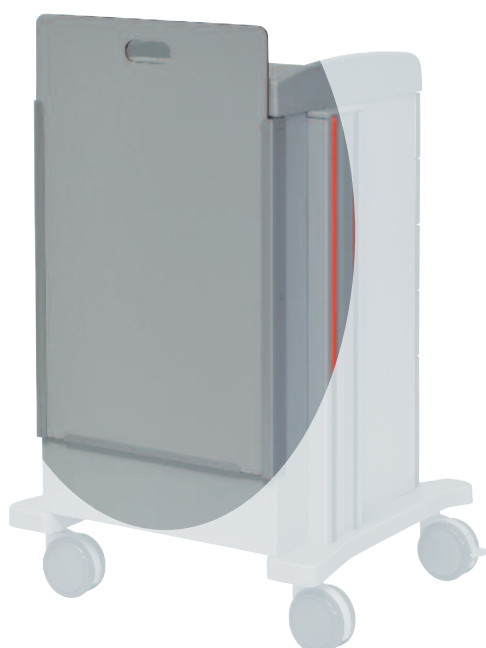

**70210**

**SOPORTE DE SUEROS REGULABLE EN ALTURA**  
**IV DRIP ROD SUPPORT, ADJUSTABLE IN HEIGHT**

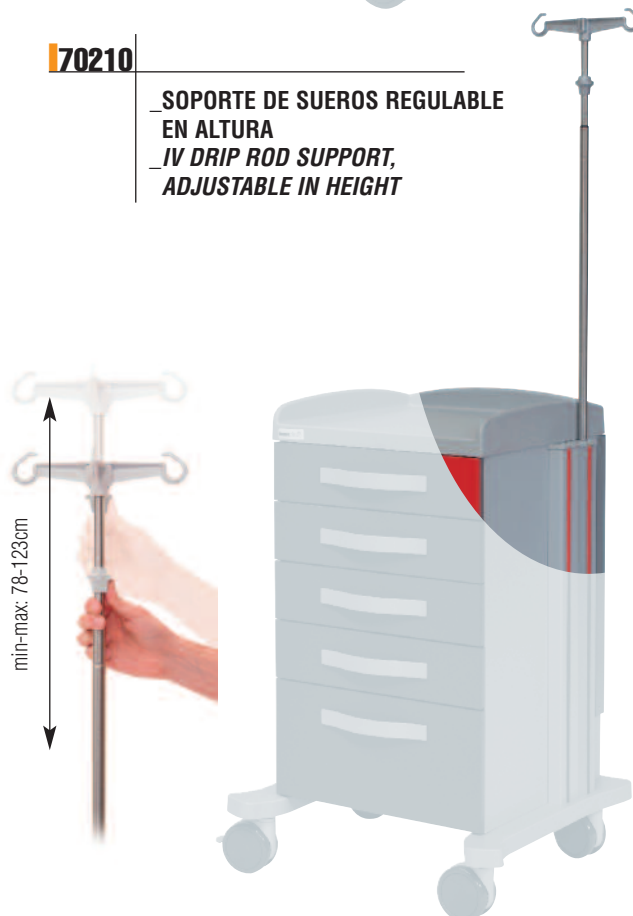



**70215**

**\_SOPORTE CON CAJAS BASCULANTES**  
**\_TILT OUT BINS SUPPORT**



\_6 cajas  
\_6 bins

\_5 cajas  
\_5 bins

**70220**

**\_CUBO DE PVC**  
**\_PVC WASTE BIN**



**70225**

**\_SOPORTE CON BIOCONTENEDOR DESECHABLE**  
**\_SHARP DISPOSAL**



**70230**

**\_CIERRE CON PRECINTOS DESECHABLES**  
Incluye 100 precintos  
**\_LOCK WITH SECURITY SEAL** Including 100 security seals

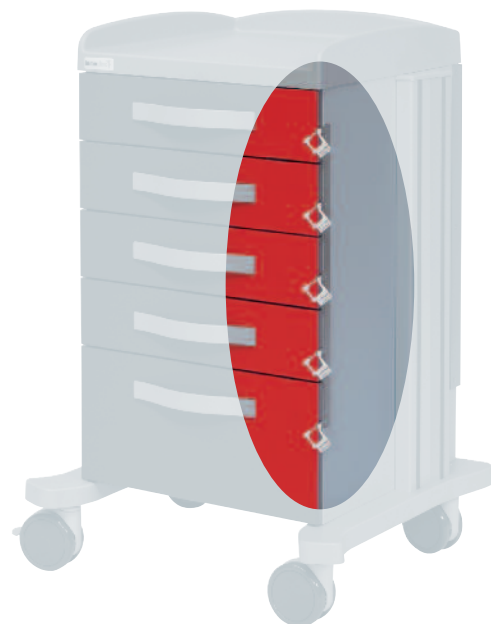



**70235**

**SOPORTE PARA ORDENADOR PORTATIL**  
**LAPTOP SUPPORT**



**70240**

**SOPORTE DISPENSADOR DE LIQUIDO DESINFECTANTE**  
**SANITIZER DISPENSER SUPPORT**



**70245**

**SEPARACIONES VARIABLES**  
**MOVABLE SEPARATIONS**





CARROS MULTIFUNCIONALES  
ACERO INOXIDABLE  
CAJONES APERTURA TOTAL



*MULTIFUNCTIONAL  
HOSPITAL TROLLEY  
STAINLESS STEEL  
TOTAL OPENING DRAWERS*

10505



10510



**CARACTERÍSTICAS TÉCNICAS**

- \_Estructura de acero inoxidable
- \_Plano superior de ABS con reborde en tres lados
- \_Cajones de PVC con autocierre, apertura 110%, frentes colores: rojo, azul, morado y pistacho
- \_Plano inferior en acero inoxidable con barandilla en tres lados
- \_Ruedas giratorias de 125mm, dos con freno
- \_Protección antichoques
- \_Equipados opcionalmente con accesorios (ver páginas 40 a 44)

**TECHNICAL CHARACTERISTICS**





- \_Stainless steel structure
- \_Upper ABS platform on top with extended up rims on three sides
- \_PVC drawers with automatic shutting system, 110% total opening, colours: red, blue, purple and light green
- \_Lower stainless steel shelf with guard rails on three sides
- \_125mm rolling wheels, two with brakes
- \_Bumper protection
- \_Equipped with optional accessories (see pages 40 to 44)

**10555**

\_Plano central e inferior en acero inoxidable con barandilla en tres lados

\_Middle and lower stainless steel shelves, both with guard rails on three sides



					
<b>10505</b>	62	52	96	18	0,31
<b>10510</b>	62	52	96	16	0,31
<b>10555</b>	62	52	96	23	0,31

Colores | Colours

			
_Azul _Blue	_Pistacho _Light green	_Morado _Purple	_Rojo _Red



10540



10535



**CARACTERÍSTICAS TÉCNICAS**

- \_Estructura de acero inoxidable
- \_Plano superior de ABS con reborde en tres lados
- \_Cajones de PVC con autocierre, apertura 110%, frentes colores: rojo, azul, morado y pistacho
- \_Ruedas giratorias de 125mm, dos con freno
- \_Protección antichoques
- \_Equipados opcionalmente con accesorios (ver páginas 40 a 44)

**TECHNICAL CHARACTERISTICS**





- \_Stainless steel structure
- \_Upper ABS platform on top with extended up rims on three sides
- \_PVC drawers with automatic shutting system, 110% total opening, colours: red, blue, purple and light green
- \_Lower open compartment
- \_125mm rolling wheels, two with brakes
- \_Bumper protection
- \_Equipped with optional accessories (see pages 40 to 44)

Colores | Colours





10500

	 cm	 cm	 cm	 kg	 m <sup>3</sup>
<b>10535</b>	62	52	96	33	0,31
<b>10540</b>	62	52	96	30	0,31
<b>10500</b>	62	52	96	40	0,31



**10550**

**CARACTERÍSTICAS TÉCNICAS**

- \_Estructura de acero inoxidable
- \_Plano superior de ABS con reborde en tres lados
- \_Cajones de PVC con autocierre, apertura 110%, frentes colores: rojo, azul, morado y pistacho
- \_Ruedas giratorias de 125mm, dos con freno
- \_Protección antichoques
- \_Equipados opcionalmente con accesorios (ver páginas 40 a 44)

**TECHNICAL CHARACTERISTICS**

- \_Stainless steel structure
- \_Upper ABS platform on top with extended up rims on three sides
- \_PVC drawers with automatic shutting system, 110% total opening, colours: red, blue, purple and light green
- \_125mm rolling wheels, two with brakes
- \_Bumper protection
- \_Equipped with optional accessories (see pages 40 to 44)

Colores | Colours



\_Azul  
\_Blue



\_Pistacho  
\_Light green



\_Morado  
\_Purple



\_Rojo  
\_Red

**10565**





- \_ Dos puertas abatibles
- \_ Interior diáfano
- \_ Two doors
- \_ Diaphanous space inside



**10575**

- \_ Dos puertas abatibles
- \_ Interior diáfano
- \_ Two doors
- \_ Diaphanous space inside



					
<b>10550</b>	62	52	96	47	0,31
<b>10565</b>	62	52	96	32	0,31
<b>10575</b>	62	52	96	36	0,31



10830



**CARACTERÍSTICAS TÉCNICAS**

- \_ Estructura acero con revestimiento en epoxy
- \_ Plano superior de ABS con reborde en tres lados
- \_ Cajones superiores de PVC con autocierre, apertura 110%, frentes colores: rojo, azul, morado y pistacho
- \_ Dos puertas abatibles colores: rojo, azul, morado y pistacho
- \_ Interior diáfano
- \_ Ruedas giratorias de 125mm, dos con freno
- \_ Protección antichoques
- \_ Equipados opcionalmente con accesorios (ver páginas 40 a 44)

10840







**TECHNICAL CHARACTERISTICS**

- \_ Epoxy steel coating structure
- \_ Upper ABS platform on top with extended up rims on three sides
- \_ Upper PVC drawers with automatic shutting system, 110% total opening, colours: red, blue, purple and light green
- \_ Two doors, with a diaphanous space inside, in different colours: red, blue, purple and light green
- \_ 125mm rolling wheels, two with brakes
- \_ Bumper protection
- \_ Equipped with optional accessories (see pages 40 to 44)



10850



	 cm	 cm	 cm	 Kg	 m <sup>3</sup>
<b>10830</b>	62	52	96	34	0,31
<b>10840</b>	62	52	96	36	0,31
<b>10850</b>	62	52	96	40	0,31

Colores | Colours

			
_Azul _Blue	_Pistacho _Light green	_Morado _Purple	_Rojo _Red



**10750**



**10780**

Plano central e inferior en acero inoxidable con barandilla en tres lados

Middle and lower stainless steel shelves, both with guard rails on three sides



**CARACTERÍSTICAS TÉCNICAS**

- \_ Estructura de acero inoxidable
- \_ Plano superior de ABS con reborde en tres lados
- \_ Cajones de PVC con autocierre, apertura 110%, frentes colores: rojo, azul, morado y pistacho
- \_ Ruedas giratorias de 125mm, dos con freno
- \_ Protección antichoques
- \_ Equipados opcionalmente con accesorios (ver páginas 40 a 44)

**TECHNICAL CHARACTERISTICS**





- \_ Stainless steel structure
- \_ Upper ABS platform on top with extended up rims on three sides
- \_ PVC drawers with automatic shutting system, 110% total opening, colours: red, blue, purple and light green
- \_ 125mm rolling wheels, two with brakes
- \_ Bumper protection
- \_ Equipped with optional accessories (see pages 40 to 44)

**10760**

\_Plano central e inferior en acero inoxidable con barandilla en tres lados

*\_Middle and lower stainless steel shelves, both with guard rails on three sides*



	 cm	 cm	 cm	 kg	 m <sup>3</sup>
<b>10750</b>	100	52	96	44	0,49
<b>10760</b>	100	52	96	48	0,49
<b>10780</b>	100	52	96	42	0,49

Colores | Colours

			
_Azul	_Pistacho	_Morado	_Rojo
_Blue	_Light green	_Purple	_Red

**10810**

*\_Plano central e inferior en acero inoxidable con barandilla en tres lados*

*\_Middle and lower stainless steel shelves, both with guard rails on three sides*



**10800**

**CARACTERÍSTICAS TÉCNICAS**

- \_Estructura de acero inoxidable*
- \_Plano superior de ABS con reborde en tres lados*
- \_Ruedas giratorias de 125mm, dos con freno*
- \_Protección antichoques*
- \_Equipados opcionalmente con accesorios (ver páginas 40 a 44)*

**TECHNICAL CHARACTERISTICS**

- \_Stainless steel structure*
- \_Upper ABS platform on top with extended up rims on three sides*
- \_125mm rolling wheels, two with brakes*
- \_Bumper protection*
- \_Equipped with optional accessories (see pages 40 to 44)*







10525



10530

Plano central e inferior en acero inoxidable con barandilla en tres lados

Middle and lower stainless steel shelves, both with guard rails on three sides

					
<b>10525</b>	62	52	96	12	0,28
<b>10530</b>	62	52	96	16	0,28
<b>10800</b>	100	52	96	18	0,46
<b>10810</b>	100	52	96	22	0,46

**CARACTERÍSTICAS TÉCNICAS**

- \_ CARRO DE PARADA
- \_ Estructura de acero inoxidable
- \_ Plano superior de ABS con reborde en tres lados
- \_ Cajones de PVC con autocierre, apertura 110%, frentes colores: rojo, azul, morado y pistacho
- \_ Ruedas giratorias de 125mm, dos con freno
- \_ Protección antichoques
- \_ Equipados con accesorios:  
**Ref. 10182/6** Soporte de sueros  
**Ref. 10182/11** Tabla de madaje cardiaco  
**Ref. 10182/10** Soporte botella de oxígeno (ver páginas 40 a 44)

**TECHNICAL CHARACTERISTICS**

- \_ CRASH TROLLEY
- \_ Stainless steel structure
- \_ ABS Upper platform on top with rims on three sides
- \_ PVC drawers with automatic shutting system, 110% total opening, colours: red, blue, purple and light green
- \_ 125mm rolling wheels, two with brakes
- \_ Bumper protection
- \_ Equipped with accessories:  
**Ref. 10182/6** IV drip rod support  
**Ref. 10182/11** Cardiac back board  
**Ref. 10182/10** Oxygen tank holder (see pages 40 to 44)

**10500**

- + 10182/6
- + 10182/11
- + 10182/10



<b>10500</b>	62	52	96	53	0,31

Colores | Colours



**CARACTERÍSTICAS TÉCNICAS**

- \_ CARRO DE ANESTESIA
- \_ Estructura de acero inoxidable
- \_ Plano superior de ABS con reborde en tres lados
- \_ Plano inferior en acero inoxidable con barandilla en tres lados
- \_ Cajones de PVC con autocierre, apertura 110%, frentes colores: rojo, azul, morado y pistacho
- \_ Ruedas giratorias de 125mm, dos con freno
- \_ Protección antichoques
- \_ Equipados con accesorios:

**Ref.10182/7** Soporte con cajas basculantes 5-6

**Ref.10182/29** Soporte con biocontenedor desechable

**Ref.10182/13** Soporte cubo PVC  
(ver páginas 40 a 44)

**TECHNICAL CHARACTERISTICS**

- \_ ANAESTHESIA TROLLEY
- \_ Stainless steel structure
- \_ Lower stainless steel shelf with guard rails on three sides
- \_ Stainless steel lower platform with rims on three sides
- \_ PVC drawers with automatic shutting system, 110% total opening, colours: red, blue, purple and light green
- \_ 125mm rolling wheels, two with brakes
- \_ Bumper protection
- \_ Equipped with accessories:

**Ref.10182/7** Tilt out bins support 5-6

**Ref.10182/29** Sharp disposal

**Ref.10182/13** PVC waste bin  
(see pages 40 to 44)

**10510**

- + 10182/7
- + 10182/29
- + 10182/13



<b>10510</b>	62	52	96	40	0,31

Colores | Colours

_Azul _Blue	_Pistacho _Light green	_Morado _Purple	_Rojo _Red



**10182-10**

**SOPORTE BOTELLA DE OXIGENO**  
**OXYGEN TANK HOLDER**



**10182-11**

**TABLA DE MASAJE CARDIACO**  
**CARDIAC BACK BOARD**

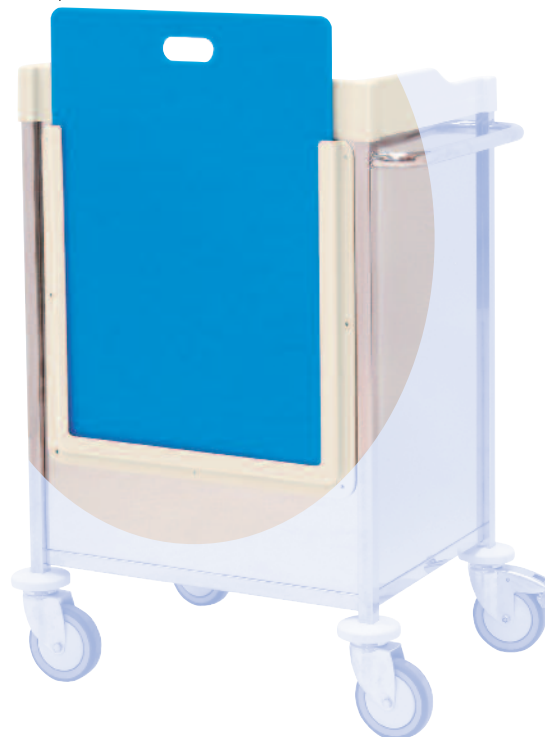

**10182-6**

**SOPORTE DE SUEROS, REGULABLE EN ALTURA**  
**IV DRIP ROD SUPPORT, ADJUSTABLE IN HEIGHT**



min-max: 78-123cm



**10182-28**

**SOPORTE GUIA CABLES**  
**CABLE GUIDE SUPPORT**





**10182-7**

**SOPORTE CON CAJAS BASCULANTES**  
**TILT OUT BINS**



**10182-15**

**ARCO SOPORTE CON DOS ESTANTES DE 62CM**  
**SUPPORT WITH TWO SHELVES OF 62CM**



**10182-13**

**CUBO DE PVC**  
**PVC WASTE BIN**



**10182-29**

**SOPORTE CON BIOCONTENEDOR DESECHABLE**  
**SHARP DISPOSAL**





**10182-9**

**SOPORTE BRAZO GIRATORIO**  
**DESFIBRILLATOR MONITOR SHELF**



**10182-2**

**BANDEJA LATERAL ABATIBLE**  
**LATERAL TRAY RETRACTABLE**



**10182-3**

**SOPORTE LATERAL**  
**SIDE SUPPORT**



**10182-27**

**SOPORTE CONTENEDOR DE CATETERES**  
**CATHETER BOX SUPPORT**



**10182-1**

**CERRADURA MANUAL CON LLAVE**  
**CENTRALIZED LOCK**

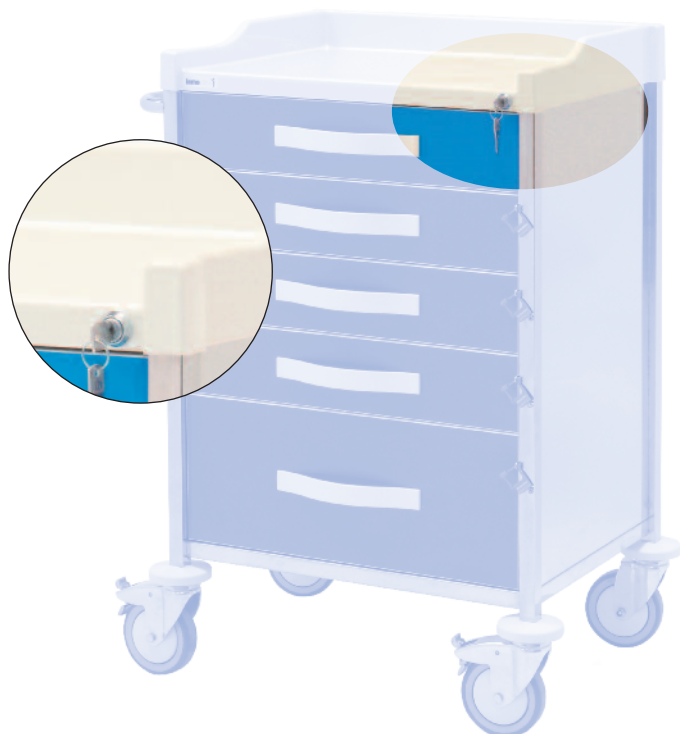

**10182-25**

**CIERRES CON PRECINTOS DESECHABLES**  
Incluye 100 precintos

**LOCK WITH SECURITY SEAL**  
Including 100 security seals

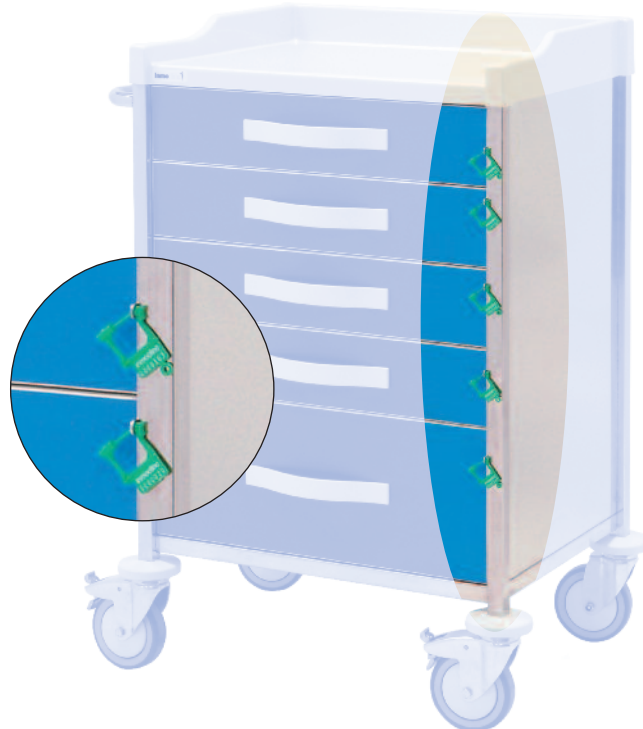

**10182-8**

**BASE DE CONEXION ELECTRICA**  
**BASE WITH MULTIPLE SOCKET PANEL HOLDERS**



**10182-26**

**SOPORTE RIEL DE FIJACION EN LATERAL**  
**LATERAL FIXING RAIL**





**10182-4**

**SEPARACIONES VARIABLES**  
**ADJUSTABLE DIVIDER FOR DRAWER**



**10182-30**

**SOPORTE DISPENSADOR DE LÍQUIDO DESINFECTANTE**  
**HAND SANITIZER DISPENSER SUPPORT**

**SEPARACIONES VARIABLES FLEXIBLES Y**  
**DESIZANTE CON PUNTOS DE ROTURA**  
**CADA 10MM**

**FLEXIBLE SLIDING DIVIDER WITH**  
**BREAKING POINTS EVERY 10MM**



CARROS  
MULTIFUNCIONALES  
CESTAS  
ISO MODULAR



*MULTIFUNCTIONAL  
HOSPITAL TROLLEY  
BASKETS  
ISO MODULAR*



Los carros que a continuación les presentamos aportan una solución práctica y de gran utilidad para usos diversos, tales como: Carros de curas, carros de anestesia, carros de urgencias, carros de parada, carros de enfermería, carros de cuidados intensivos, carros de medicación, carros de U.C.I., carros de almacenamiento, carros de historias clínicas, etc.

*The following trolleys that we present you contribute a practical solution and very useful for diverse uses, such as: clinic file trolleys, cure trolleys, anesthesia, urgencies, infirmary, medication, I.C.U.*

\_Incluye cestas ISO modular extraibles 600 x 400mm

\_Includes removable baskets ISO modular 600 x 400mm

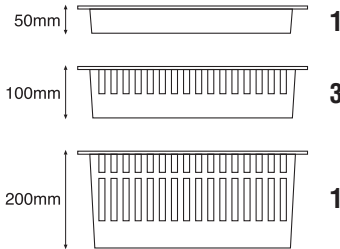

**50000**

- + 50900
- + 50905
- + 50910
- + 50920
- + 50935
- + 50955

**50000**

**CARACTERÍSTICAS TÉCNICAS**

- \_Estructura de aluminio y paneles estratificados con revestimiento plastificado
- \_Plano superior de ABS con reborde en tres lados
- \_Base con protección antigolpes de poliuretano integral (PUR)
- \_Guías telescópicas con autocierre y marco ISO 600 x 400mm
- \_Apertura total 110%
- \_Empujador ergonómico de poliuretano integral (PUR)
- \_Ruedas de 125mm dos con freno
- \_Equipados opcionalmente con accesorios (ver páginas 70 a 74)
- \_Elija colores en carta de colores (ver página 75)

**TECHNICAL CHARACTERISTICS**

- \_Aluminium structure and stratified side panels with plasticized coating
- \_Upper ABS platform on top with extended up rims on three sides
- \_Base with polyurethane integral bumper protection (PUR)
- \_Telescopic slides with automatic shutting system and frame ISO 600 x 400mm
- \_Total opening 110%
- \_Ergonomic pushing handle of polyurethane integral (PUR)
- \_125mm rolling wheels, two with brakes
- \_Equipped with optional accessories. (see page 70 to 74)
- \_Choose your colour (see page 75)



<b>50000</b>	80	58	98	60	0.45



**50030**

+50510 (2)





**50030**

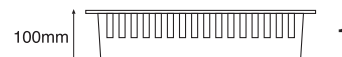

\_Incluye cestas ISO modular extraibles 600 x 400mm

\_Includes removable baskets ISO modular 600 x 400mm



					
<b>50030</b>	80	58	98	60	0.45
<b>50035</b>	80	58	98	63	0.45



\_Incluye cestas ISO modular extraíbles 600 x 400mm

\_Includes removable baskets ISO modular 600 x 400mm

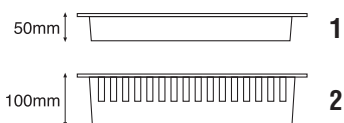

50035

**CARACTERÍSTICAS TÉCNICAS**

- \_Estructura de aluminio y paneles estratificados con revestimiento plastificado
- \_Plano superior de ABS con reborde en tres lados
- \_Base con protección antigolpes de poliuretano integral (PUR)
- \_Guías telescópicas con autocierre y marco ISO 600 x 400mm
- \_Apertura total 110%
- \_Parte inferior panel con guías para cestas o estantes
- \_Empujador ergonómico de poliuretano integral (PUR)
- \_Ruedas de 125mm dos con freno
- \_Equipados opcionalmente con accesorios (ver páginas 70 a 74)
- \_Elija colores en carta de colores (ver página 75)

**TECHNICAL CHARACTERISTICS**

- \_Aluminium structure and stratified side panels with plasticized coating
- \_Upper ABS platform on top with extended up rims on three sides
- \_Base with polyurethane integral bumper protection (PUR)
- \_Telescopic slides with automatic shutting system and frame ISO 600 x 400mm
- \_Total opening 110%
- \_Lower part with liner panels for baskets or shelves
- \_Ergonomic pushing handle of polyurethane integral (PUR)
- \_125mm rolling wheels, two with brakes
- \_Equipped with optional accessories. (see page 70 to 74)
- \_Choose your colour (see page 75)

50050

+ 50915



\_Incluye cestas ISO modular extraibles 600 x 400mm

\_Includes removable baskets ISO modular 600 x 400mm



50050



50055

+ 50920  
+ 50945



\_Incluye cestas ISO modular extraíbles 600 x 400mm

\_Includes removable baskets ISO modular 600 x 400mm

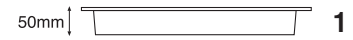



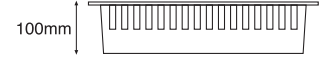

1



2

50055



					
50050	80	58	98	70	0.45
50055	80	58	98	75	0.45

### CARACTERÍSTICAS TÉCNICAS

- \_Estructura de aluminio y paneles estratificados con revestimiento plastificado
- \_Plano superior de ABS con reborde en tres lados
- \_Base con protección antigolpes de poliuretano integral (PUR)
- \_Guías telescópicas con autocierre y marco ISO 600 x 400mm
- \_Apertura total 110%
- \_Parte inferior panel con guías para cestas o estantes
- \_Empujador ergonómico de poliuretano integral (PUR)
- \_Ruedas de 125mm dos con freno
- \_Equipados opcionalmente con accesorios (ver páginas 70 a 74)
- \_Elija colores en carta de colores (ver página 75)

### TECHNICAL CHARACTERISTICS

- \_Aluminium structure and stratified side panels with plasticized coating
- \_Upper ABS platform on top with extended up rims on three sides
- \_Base with polyurethane integral bumper protection (PUR)
- \_Telescopic slides with automatic shutting system and frame ISO 600 x 400mm
- \_Total opening 110%
- \_Lower part with liner panels for baskets or shelves
- \_Ergonomic pushing handle of polyurethane integral (PUR)
- \_125mm rolling wheels, two with brakes
- \_Equipped with optional accessories. (see page 70 to 74)
- \_Choose your colour (see page 75)

50785

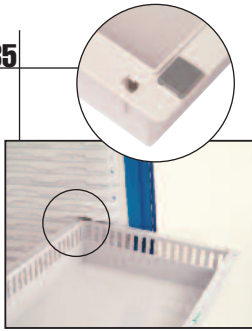

- \_Tope de salida de bandeja incluido
- \_Pull-out stopper included



- \_Incluye cestas ISO modular extraíbles 600 x 400mm
- \_Includes removable baskets ISO modular 600 x 400mm

50mm |  2

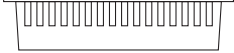
100mm |  6

- \_Pueden poner cestas según sus necesidades
- \_You can put baskets according your needs

50100





**CARACTERÍSTICAS TÉCNICAS**

- \_Estructura de aluminio y paneles estratificados con revestimiento plastificado
- \_Plano superior de ABS con reborde en tres lados
- \_Base con protección antigolpes de poliuretano integral (PUR)
- \_Panel con guías para cestas o estantes ISO 600 x 400mm
- \_Dos puertas abatibles
- \_Cerradura con llave
- \_Empujador ergonómico de poliuretano integral (PUR)
- \_Ruedas de 125mm dos con freno
- \_Equipados opcionalmente con accesorios (ver páginas 70 a 74)
- \_Elija colores en carta de colores (ver página 75)

**TECHNICAL CHARACTERISTICS**

- \_Aluminium structure and stratified side panels with plasticized coating
- \_Upper ABS platform on top with extended up rims on three sides
- \_Base with polyurethane integral bumper protection (PUR)
- \_Panel for baskets or shelves ISO 600 x 400mm
- \_Two doors
- \_Locking key
- \_Ergonomic pushing handle of polyurethane integral (PUR)
- \_125mm rolling wheels, two with brakes
- \_Equipped with optional accessories. (see page 70 to 74)
- \_Choose your colour (see page 75)



					
50100	80	58	120	62	0.56
50110	80	58	156	75	0.72

50785

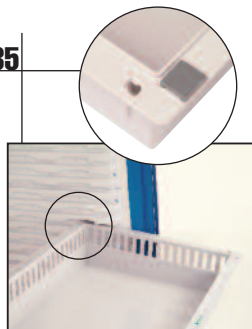

\_Tope de salida de bandeja incluido

\_Pull-out stopper included



50110

\_Incluye cestas ISO modular extraíbles 600 x 400mm  
\_Includes removable baskets ISO modular 600 x 400mm

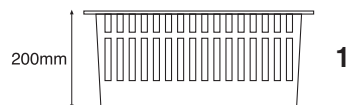
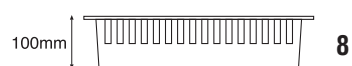

\_Pueden poner cestas según sus necesidades  
\_You can put baskets according your needs



50070

- + 50915
- + 50920
- + 50925

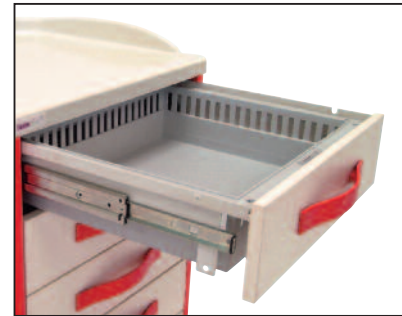

10206



**CARACTERÍSTICAS TÉCNICAS**

- \_ Estructura de aluminio y paneles estratificados con revestimiento plastificado
- \_ Plano superior de ABS con reborde en tres lados
- \_ Base con protección antigolpes de polietileno
- \_ Guías telescópicas con autocierre y marco
- \_ Seis cajones con cestas ISO de 450x400x100mm
- \_ Apertura total 110%
- \_ Empujador lateral
- \_ Ruedas de 125mm, dos con freno
- \_ Consultar accesorios (ver páginas 70 a 74)
- \_ **Colores disponibles: rojo, azul y verde**

**TECHNICAL CHARACTERISTICS**

- \_ Aluminium structure and stratified side panels with plasticized coating
- \_ ABS platform on top with extended up rims on three sides
- \_ Base with polyethylene integral bumper protection (PUR)
- \_ Telescopic slides with automatic shutting system and frame
- \_ Six drawers with ISO basket of 450x400x100mm
- \_ 100% opening
- \_ Pushing handle
- \_ 125mm rolling wheels, two with brakes
- \_ Consult accessories (see page 70 to 74)
- \_ **Colours available: red, blue and green**

	↔ cm	↗ cm	↕ cm	🔒	m <sup>3</sup>
--	---------	---------	---------	---	----------------

10204	62	54	98	57	0.33
10206	62	54	98	57	0.33

**50075**

- \_Panel con guías para cestas
- \_Cinco cestas ISO DE 450x400x100mm (sin separadores) (opcional)

- \_Panels with slides for baskets
- \_Five ISO baskets of 450x400x100mm (dividers not include) ( optional)



**CARACTERÍSTICAS TÉCNICAS**

- \_Estructura de aluminio y paneles estratificados con revestimiento plastificado
- \_Plano superior de ABS con reborde en tres lados
- \_Base con protección antigolpes de polietileno
- \_Dos puertas abatibles
- \_Cerradura con llave
- \_Empujador lateral
- \_Ruedas de 125mm, dos con freno
- \_Consultar accesorios (ver páginas 70 a 74)
- \_Colores disponibles: rojo, azul y verde**

**TECHNICAL CHARACTERISTICS**

- \_Aluminium structure and stratified side panels with plasticized coating
- \_ABS platform on top with extended up rims on three sides
- \_Base with polyethylene integral bumper protection (PUR)
- \_Two doors
- \_Locking key
- \_Pushing handle
- \_125mm rolling wheels, two with brakes
- \_Consult accessories (see page 70 to 74)
- \_Colours available: red, blue and green**

**50115**

+ 50520

**50115**

- \_Encimera plastificada
- \_5 guías para cestas o estantes

- \_Plasticized top
- \_5 guides for baskets or shelves

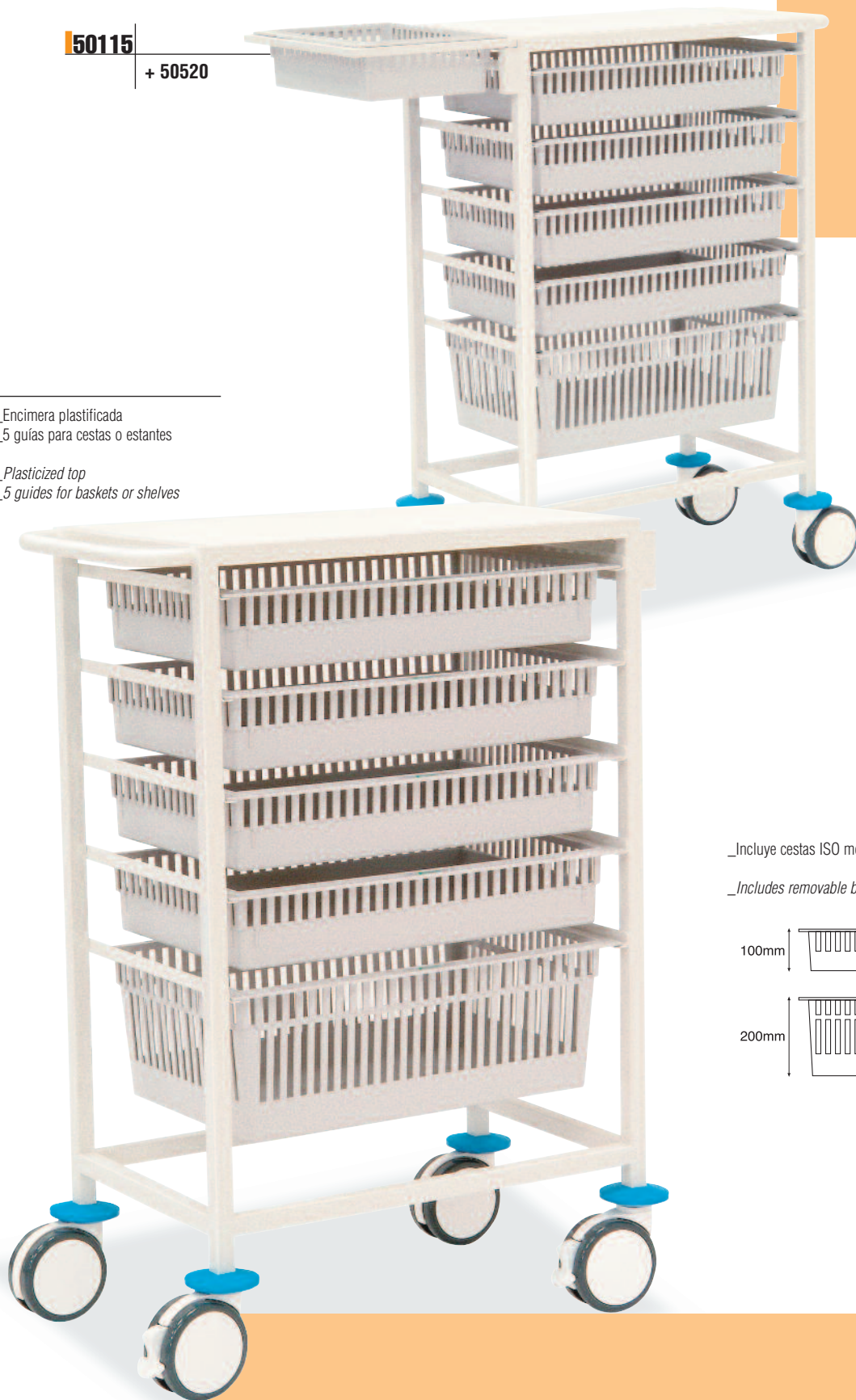

\_Incluye cestas ISO modular extraíbles 600 x 400mm

\_Includes removable baskets ISO modular 600 x 400mm

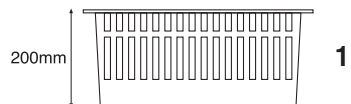



50785

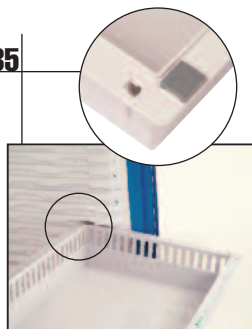

- \_Tope de salida de bandeja incluido
- \_Pull-out stopper included

50120

- \_10 guías para cestas o estantes
- \_10 guides for baskets or shelves

- \_Incluye cestas ISO modular extraíbles 600 x 400mm
- \_Includes removable baskets ISO modular 600 x 400mm

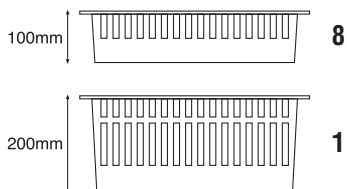





**CARACTERÍSTICAS TÉCNICAS**

- \_Estructura de acero con revestimiento en epoxy
- \_Parte superior estante
- \_Empujador
- \_Protección antigolpes
- \_Ruedas de 125mm dos con freno
- \_OPCIONAL: Soporte para bandeja de 400 x 300mm

**TECHNICAL CHARACTERISTICS**

- \_Steel structure with epoxy coating
- \_upper shelf
- \_Pushing handle
- \_Bumper protection
- \_125mm rolling wheels, two with brakes
- \_OPTIONAL: side support for shelf of 400 x 300mm

	 cm	 cm	 cm	 kg	 m <sup>3</sup>
50115	74	42	110	25	0.34
50120	74	42	157	36	0.49





**50200**

- \_ Dos puertas abatibles
- \_ Mesa escritorio extraible
- \_ Two doors
- \_ Sliding out writing-desk

**CARACTERÍSTICAS TÉCNICAS**

- \_ Estructura de aluminio y paneles estratificados con revestimiento plastificado
- \_ Plano superior de ABS con reborde en tres lados
- \_ Base con protección antigolpes de poliuretano integral (PUR)
- \_ Mesa escritorio extraible
- \_ 22 divisores para radiografías de 360 x 430mm
- \_ Empujador ergonómico
- \_ Ruedas de 125mm dos con freno
- \_ Equipados opcionalmente con accesorios (ver páginas 70 a 74)
- \_ Elija colores en carta de colores (ver página 75)

**TECHNICAL CHARACTERISTICS**

- \_ Aluminium structure and stratified side panels with plasticized coating
- \_ Upper ABS platform on top with extended up rims on three sides
- \_ Base with polyurethane integral bumper protection (PUR)
- \_ Sliding out writing-desk
- \_ 22 compartments for x-rays of 360 x 430mm
- \_ Ergonomic pushing handle
- \_ 125mm rolling wheels, two with brakes
- \_ Equipped with optional accessories. (see page 70 to 74)
- \_ Choose your colour (see page 75)

**50215**

\_Carpeta para historias clínicas





\_Folder for clinic files



**50220**

\_Un cajón para carpetas verticales de historias clínicas  
\_11 divisores para radiografías de 360 x 430mm

\_One drawer for vertical clinic files folders  
\_11 compartments for x-rays of 360 x 430mm

	 cm	 cm	 cm	 kg	 m <sup>3</sup>
<b>50200</b>	80	58	120	90	0.56
<b>50210</b>	80	58	120	77	0.56



Además de los carros también encontrará un conjunto de bandejas y separadores que de una manera fácil e intuitiva le permitirá personalizar a su gusto o necesidades todos los compartimentos, creando así un espacio de trabajo más cómodo y práctico. Los separadores le permiten la compartimentación de las cestas tanto horizontal como transversalmente.

*In addition to the trolleys, you will also find a set of trays and dividers that an easy and intuitive way, will allow you to personalizing according your preferences or needs of all compartments, creating a comfortable and practical space to work. The dividers allow you the compartment of the baskets horizontal as well as transversely.*

**50500**

\_Cestas ISO modular de ABS

\_ISO Modular basket of ABS



**50505**

\_Cestas ISO modular de ABS

\_ISO Modular basket of ABS



**50510**



**50515**



**50520**



<b>50500</b>	60	40	1,5
<b>50505</b>	60	40	5
<b>50510</b>	60	40	10
<b>50515</b>	60	40	20
<b>50520</b>	40	30	10

**CARACTERÍSTICAS TÉCNICAS**

\_Cesta ISO modular para medicamentos y materiales fungibles  
\_Fabricada en ABS

**TECHNICAL CHARACTERISTICS**

\_ISO Modular basket for drugs and expendable goods  
\_Made of ABS

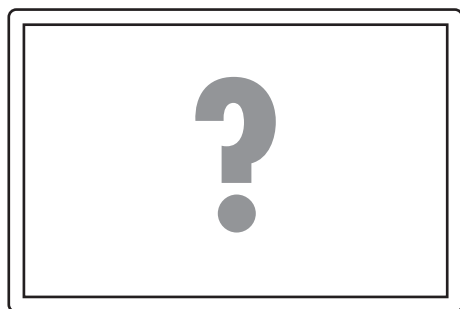

\_Elige tus necesidades

\_Your needs

**50630**

\_Separador ajustable cada 10mm

\_Adjustable cross divider every 10mm

600 x 50mm

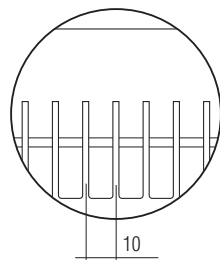
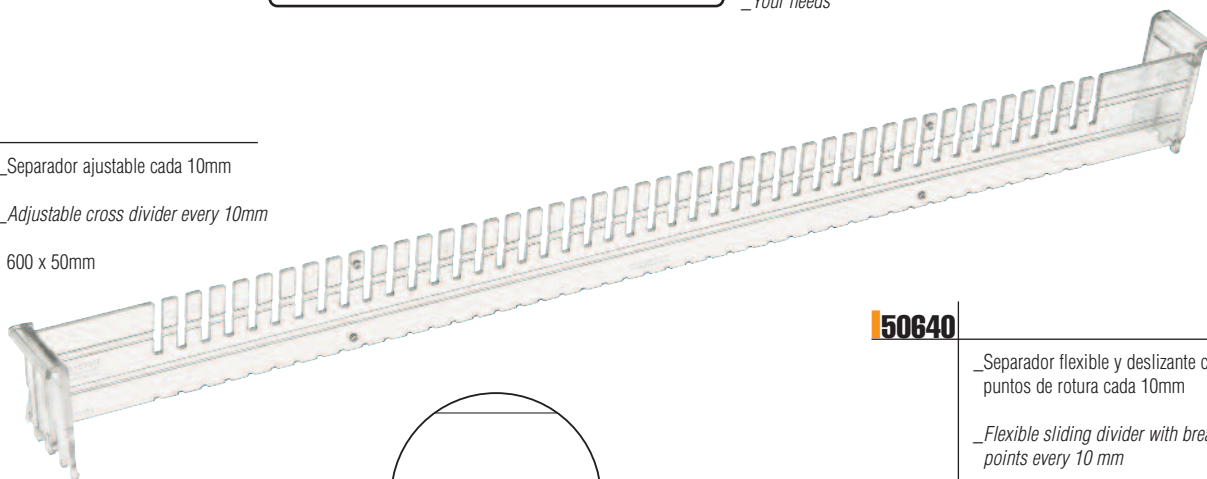

**50640**

\_Separador flexible y deslizante con puntos de rotura cada 10mm

\_Flexible sliding divider with breaking points every 10 mm

170 x 45mm

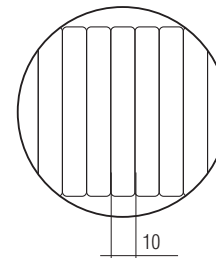
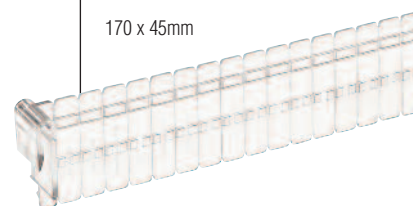

**50635**

400 x 50mm

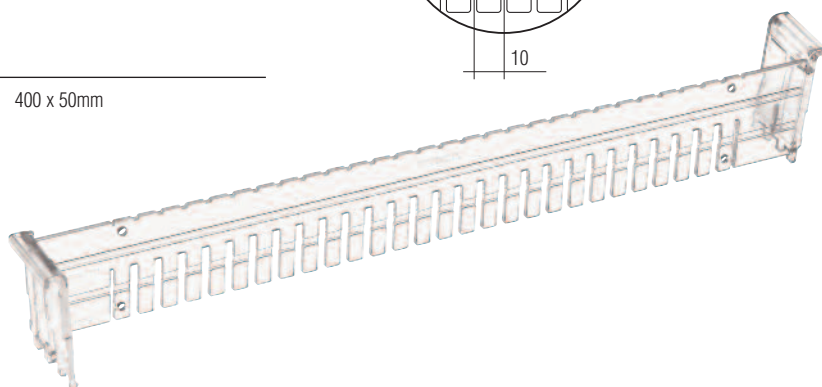

\_Puedes obtener las medidas que necesites con solo romper por los puntos de rotura

\_To shorten the dividers, just break off the scored sections

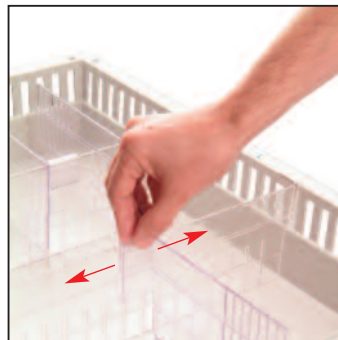
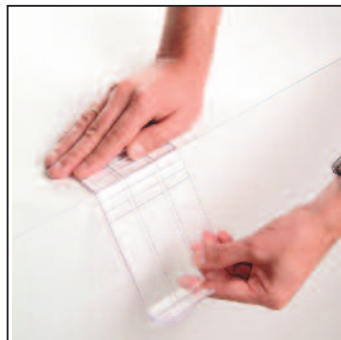

\_Los separadores deslizantes son fáciles de cambiar y mover

\_The sliding dividers are really easy to move and change

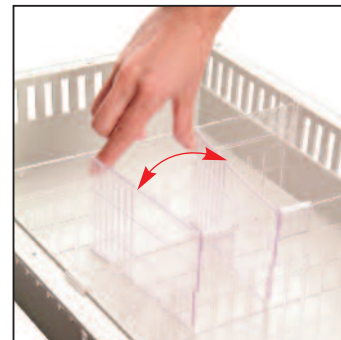

Separaciones para cestas de 600 x 400 x 50mm  
 Dividers for baskets of 600 x 400 x 50mm



**50600**

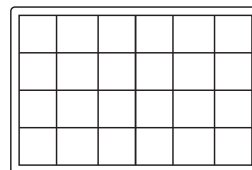

**24**

\_Compartimentos  
 \_Compartment

**50605**

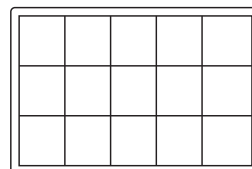

**15**

\_Compartimentos  
 \_Compartment

**50610**

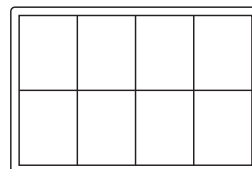

**8**

\_Compartimentos  
 \_Compartment

\_Separadores variables ajustables cada 10mm

\_Adjustable cross dividers every 10mm



**50615**

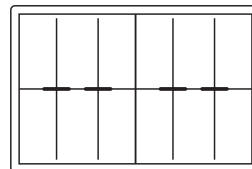

**12**

\_Compartimentos  
 \_Compartment

**50620**

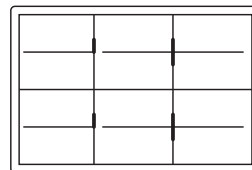

**12**

\_Compartimentos  
 \_Compartment

**50625**

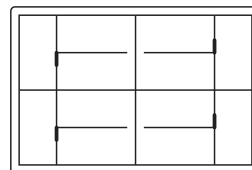

**12**

\_Compartimentos  
 \_Compartment

\_Separadores variables y deslizantes con puntos de rotura cada 10mm

\_Adjustable cross dividers and flexible sliding dividers with breaking points every 10mm

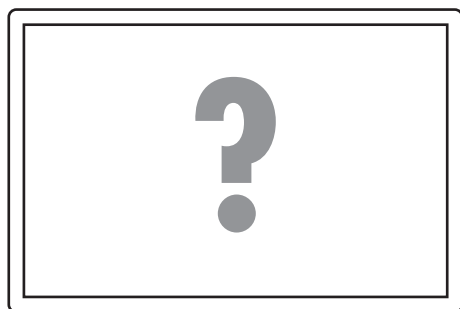

\_Elige tus necesidades

\_Your needs

**50675**

\_Separador ajustable cada 20 mm

\_Adjustable cross dividers every 20mm

600 x 100mm

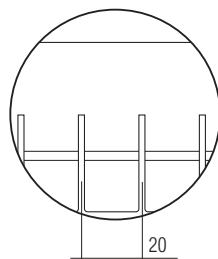
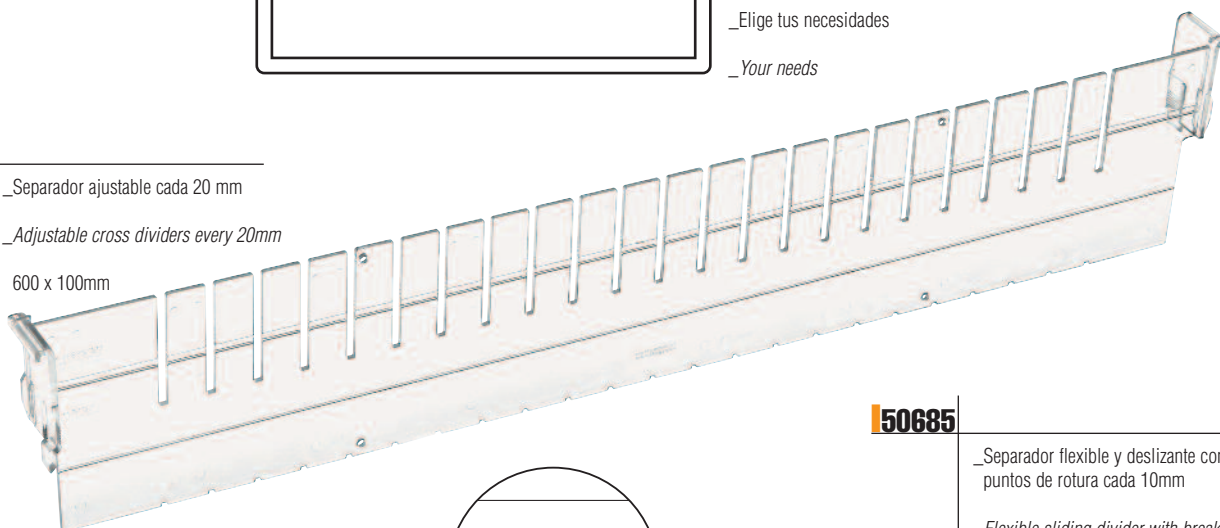

20

**50685**

\_Separador flexible y deslizable con puntos de rotura cada 10mm

\_Flexible sliding divider with breaking points every 10mm

170 x 100mm

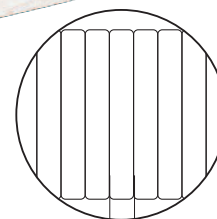
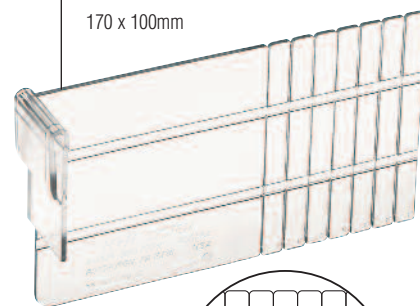

10

**50680**

400 x 100mm

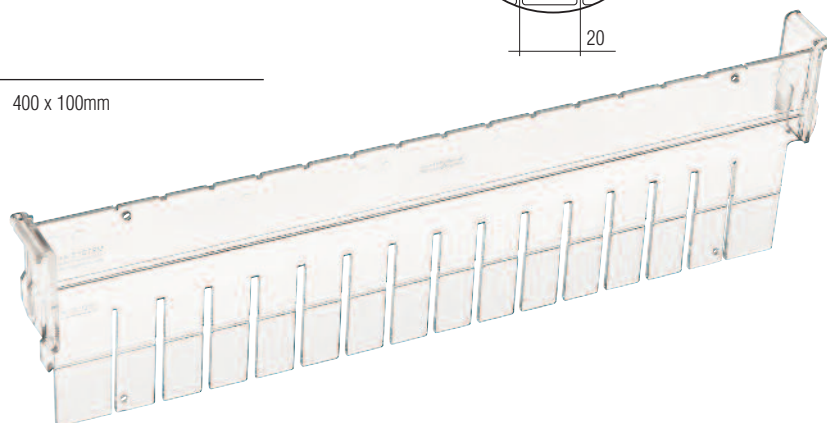

\_Puedes obtener las medidas que necesites con solo romper por los puntos de rotura

\_To shorten the dividers, just break off the scored sections

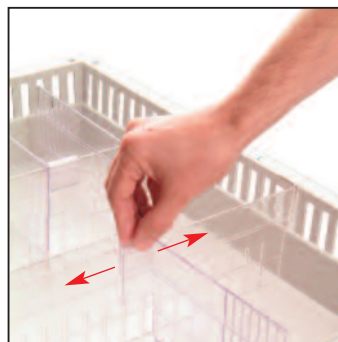
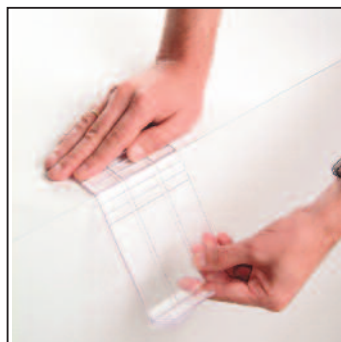

\_Los separadores deslizantes son fáciles de cambiar y mover

\_The sliding dividers are really easy to move and change

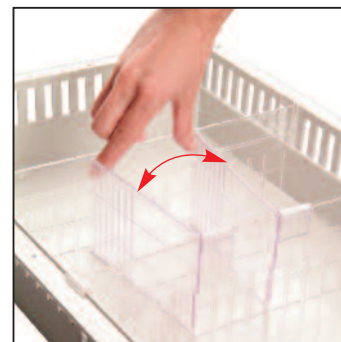



Separaciones para cestas de 600 x 400 x 100mm  
 Dividers for baskets of 600 x 400 x 100mm



**50645**

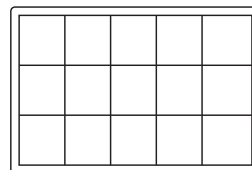

**15**

\_Compartimentos  
 \_Compartment

**50650**

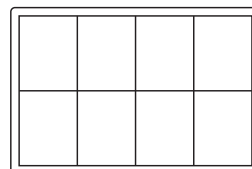

**8**

\_Compartimentos  
 \_Compartment

**50655**

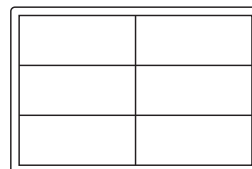

**6**

\_Compartimentos  
 \_Compartment

\_Separadores variables ajustables cada 20mm

\_Adjustable cross divider every 20mm



**50660**

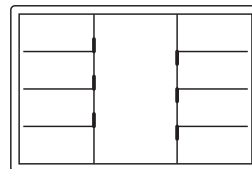

**9**

\_Compartimentos  
 \_Compartment

**50665**

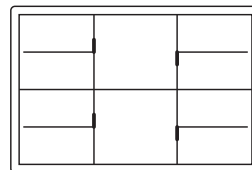

**10**

\_Compartimentos  
 \_Compartment

**50670**

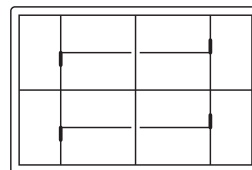

**12**

\_Compartimentos  
 \_Compartment

\_Separadores variables y deslizantes con puntos de rotura cada 10mm

\_Adjustable cross divider and flexible sliding dividers with breaking points every 10mm



\_Elige tus necesidades

\_Your needs

**50720**

\_Separador ajustable cada 140mm

\_Adjustable cross divider every 140mm

600 x 200mm

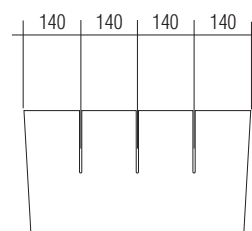
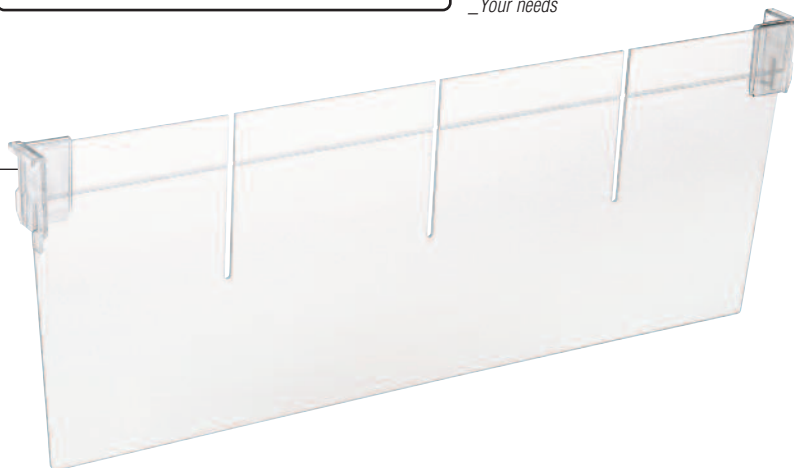

**50725**

\_Separadores ajustable cada 60mm

\_Adjustable cross divider every 60mm

400 x 200mm

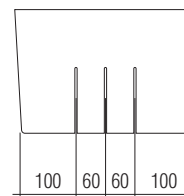
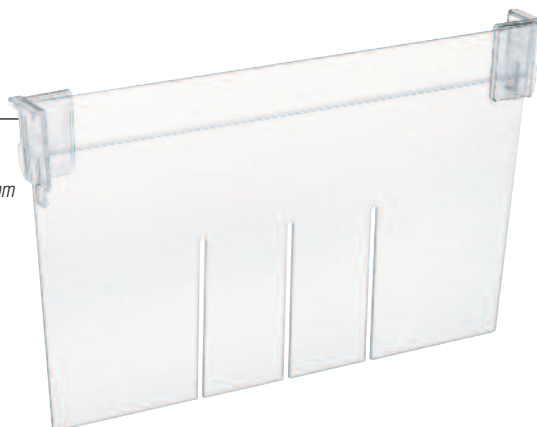

\_Los separadores deslizantes son fáciles de cambiar y mover

\_The sliding dividers are really easy to move and change

**50730**

\_Separador deslizante

\_Sliding divider

150 x 200mm



Separaciones para cestas de 600 x 400 x 200mm

Dividers for baskets of 600 x 400 x 200mm



**50690**

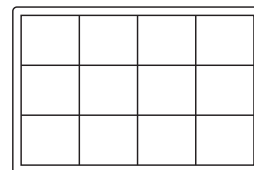

**12**

\_Compartimentos  
\_Compartment

**50695**

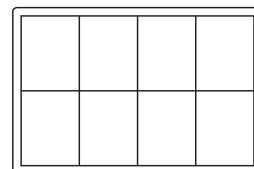

**8**

\_Compartimentos  
\_Compartment

**50700**

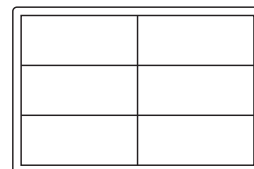

**6**

\_Compartimentos  
\_Compartment

\_Separadores variables y ajustables

\_Adjustable cross dividers

**50705**

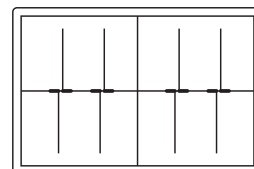

**12**

\_Compartimentos  
\_Compartment

**50710**

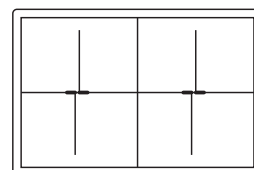

**8**

\_Compartimentos  
\_Compartment

**50715**

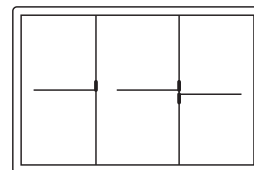

**6**

\_Compartimentos  
\_Compartment

\_Separadores variables y deslizantes

\_Adjustable cross dividers with sliding dividers





**50735**

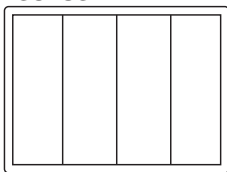

4

\_Separadores variables ajustables cada 20mm

\_Adjustable cross dividers every 20mm

**50740**

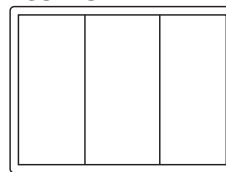

3

\_Compartimentos  
\_Compartment

**50745**

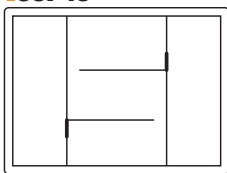

5

\_Separadores variables y deslizantes con puntos de rotura cada 10mm

\_Adjustable cross divider and flexible sliding dividers with breaking points every 10mm

**50750**

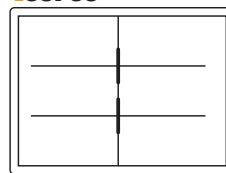

6

\_Compartimentos  
\_Compartment

**50755**

\_Separador ajustable cada 20 mm

\_Adjustable cross dividers every 20mm

300 x 100mm

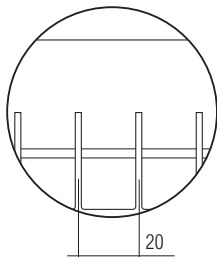
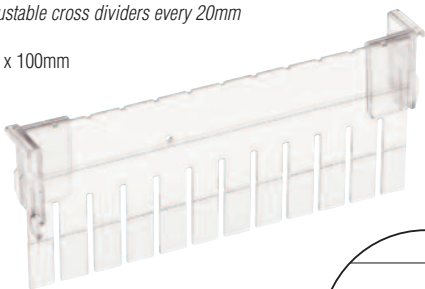

**50760**

\_Separador flexible y deslizante con puntos de rotura cada 10mm

\_Flexible sliding divider with breaking points every 10mm

170 x 100mm

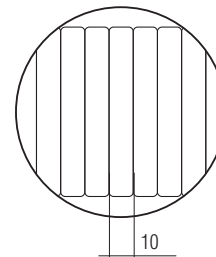
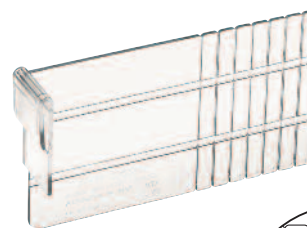

\_Puedes obtener las medidas que necesitas con solo romper por los puntos de rotura

\_To shorten the dividers, just break off the scored sections

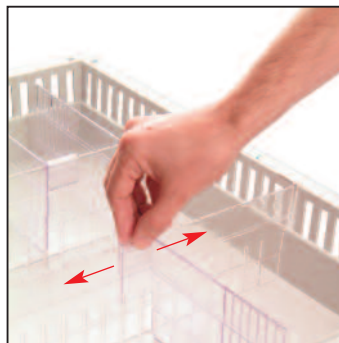
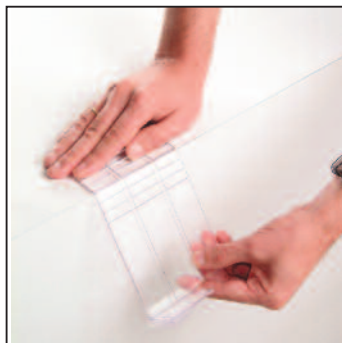

\_Los separadores deslizantes son fáciles de cambiar y mover

\_The sliding dividers are really easy to move and change

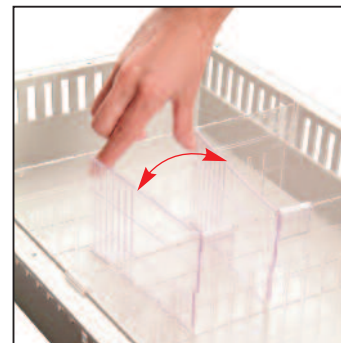



**\_Accesorios para carros hospitalarios multifuncionales**  
**\_Personalice los carros según sus necesidades**

***\_Accessories for multifunctional hospital trolleys***  
***\_Personalize the trolleys according your needs***



50900

SOPORTE BOTELLA DE OXIGENO  $\varnothing 110 \times 780$  mm  
OXYGEN TANK HOLDER  $\varnothing 110 \times 780$  mm



50900

SOPORTE BOTELLA DE OXIGENO  $\varnothing 140 \times 570$  mm  
OXYGEN TANK HOLDER  $\varnothing 140 \times 570$  mm



50905

TABLA DE MASAJE CARDIACO  
CARDIAC BACK BOARD



50910

SOPORTE DE SUEROS, REGULABLE EN ALTURA  
IV DRIP ROD SUPPORT, ADJUSTABLE IN HEIGHT



50915

\_SOPORTE CON CAJAS BASCULANTES  
\_TILT OUT BINS



50920

\_CUBO DE PVC  
\_PVC WASTE BIN



50925

\_SOPORTE CON BIOCONTENEDOR DESECHABLE  
\_SHARP DISPOSAL



50930

\_ESTANTE DE 600 x 400 mm  
\_TRAY OF 600 x 400mm

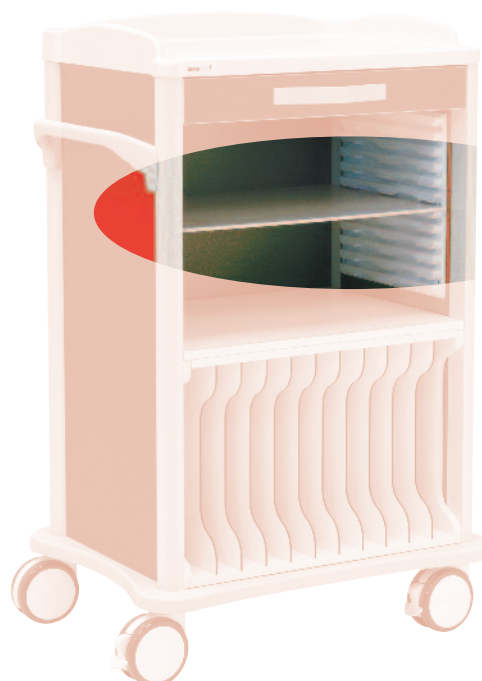



50935

SOPORTE BRAZO GIRATORIO  
DESFIBRILLATOR MONITOR SHELF

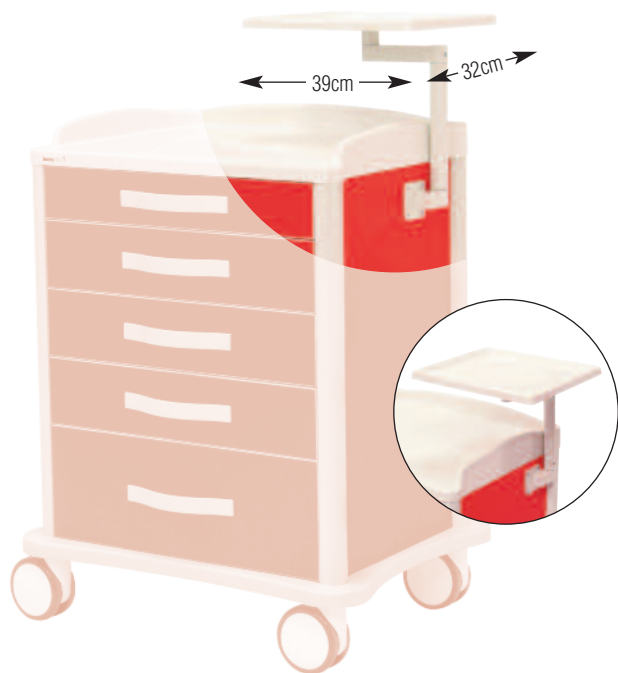

50940

BANDEJA LATERAL EXTRAIBLE  
LATERAL PULL-OUT SHELF

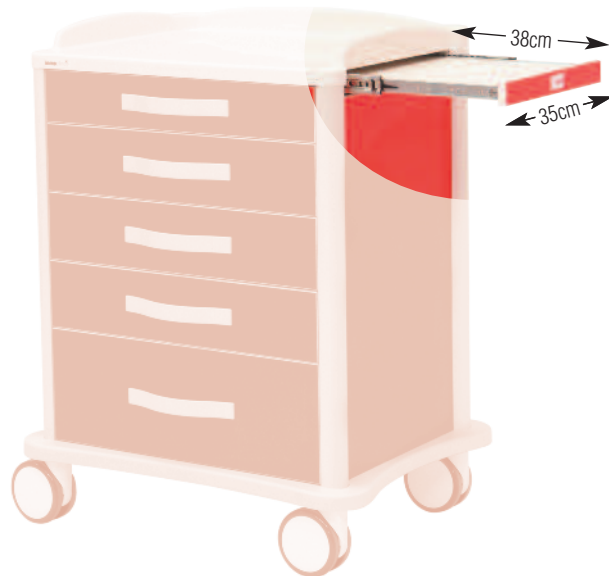

50945

SOPORTE CON CESTA DE 400 x 300 mm  
SIDE BASKET OF 400 x 300 mm

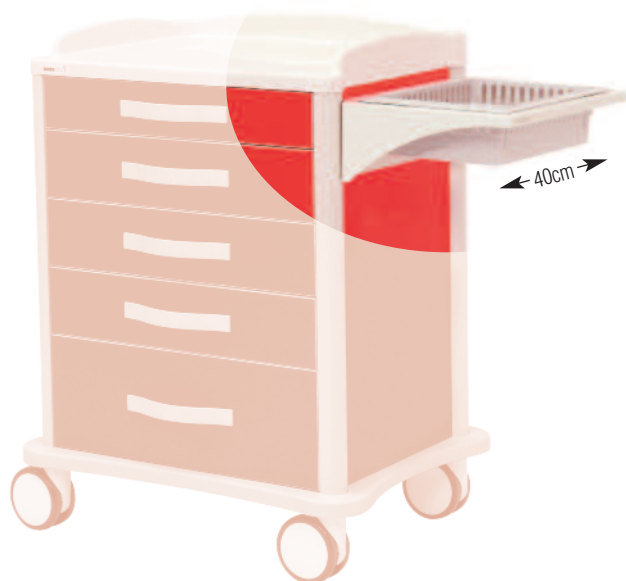

50950

SOPORTE LATERAL  
SIDE SUPPORT

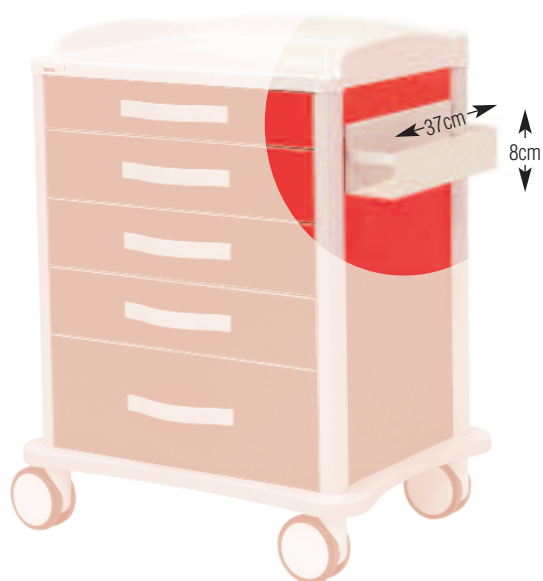



**50955**

**CIERRES CON PRECINTOS DESECHABLES**

Incluye 100 precintos

**LOCK WITH SECURITY SEAL**

Including 100 security seals

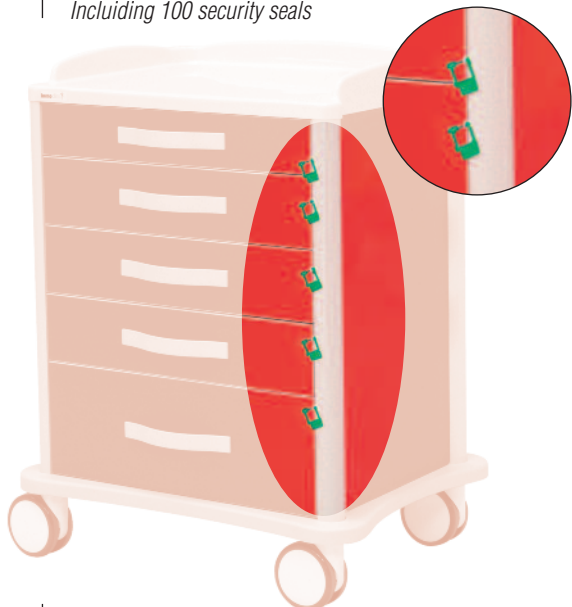

**50965**

**CERRADURA MANUAL CON LLAVE**

LOCK WITH KEY

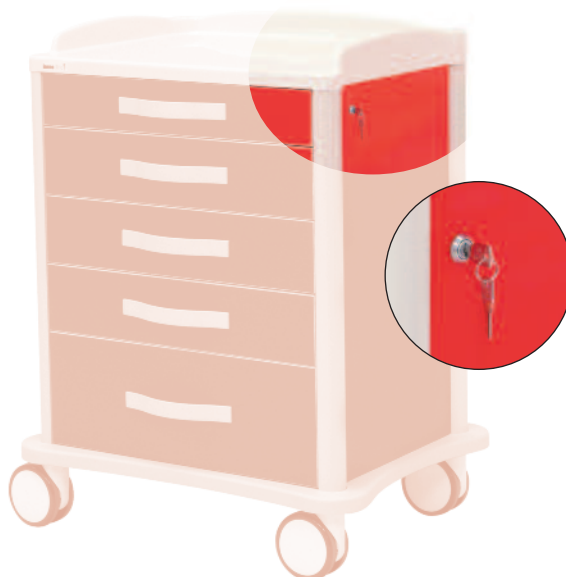

**50960**

**100 PRECINTOS DESECHABLES**

100 SECURITY SEALS



**50970**

**BASE DE CONEXION ELECTRICA**

BASE WITH MULTIPLE SOCKET PANEL HOLDERS



**50975**

**SOPORTE GUIA CABLES**

CABLE GUIDE SUPPORT





50980

SOPORTE CONTENEDOR DE CATETERES  
CATHETER CONTAINER SUPPORT

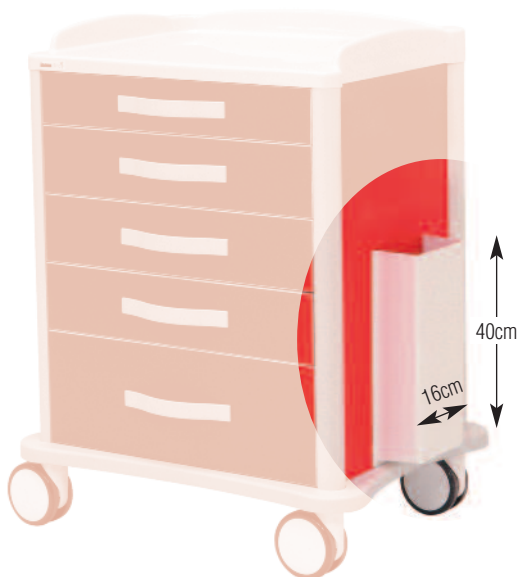

50985

SOPORTE DOBLE CONTENEDOR DE CATETERES  
DOUBLE CATHETER CONTAINER SUPPORT

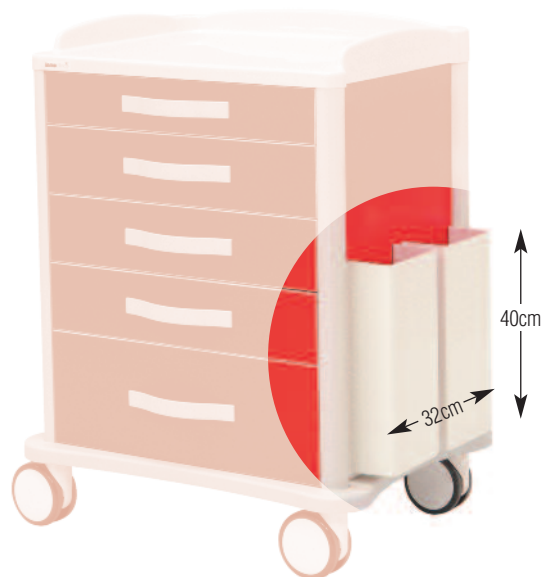

50990

SOPORTE RIEL DE FIJACION EN TRASERA  
FIXING RAIL ON BACK SIDE



50995

SOPORTE RIEL DE FIJACION EN LATERAL  
LATERAL FIXING RAIL



1

\_Indique los colores de las patas (1), paneles (2), frentes de cajones (3) y tiradores (4) en la hoja de pedido con su letra correspondiente.  
 \_No se aceptarán pedidos que no se hagan por medio de la hoja de pedido oficial que les proporcionamos.  
 \_Indicate the requested colours of the legs (1), panels (2), drawer fronts (3) and handles (4) in your order form with it's corresponding letter.  
 \_We will not accept orders that are not made in the officially order from that we provide to you.

\_Personalice los colores del carro a su gusto.  
 \_Personalize the colours of the trolley according to your need.

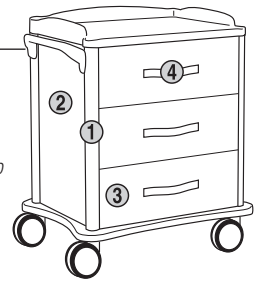

1



2



3



4



\_Inoxidable  
 \_Stainless steel  
**S**

\_Azul  
 \_Blue  
**B**

\_Verde  
 \_Green  
**G**

\_Amarillo  
 \_Yellow  
**Y**

\_Naranja  
 \_Orange  
**O**

\_Rojo  
 \_Red  
**R**

\_Beige  
 \_Beige  
**W**

CARROS  
HOSPITALARIOS  
MULTIFUNCIONALES

*MULTIFUNCTIONAL  
HOSPITAL TROLLEY*

3

C/ Serranía de Cuenca, 10  
Pol. Ind. El Olivar  
28500 Arganda del Rey (Madrid) Spain  
Telf.: 91 872 96 16  
91 872 96 17  
91 872 96 18  
Fax: 91 872 00 40  
info@inmoclinc.com  
www.inmoclinc.com